

RADIO'S LIVEST MAGAZINE



June  
25 Cents  
Canada 30¢

# Radio-Craft

*Special*  
**AUTO-RADIO  
NUMBER**

HUGO GERNSBACK Editor

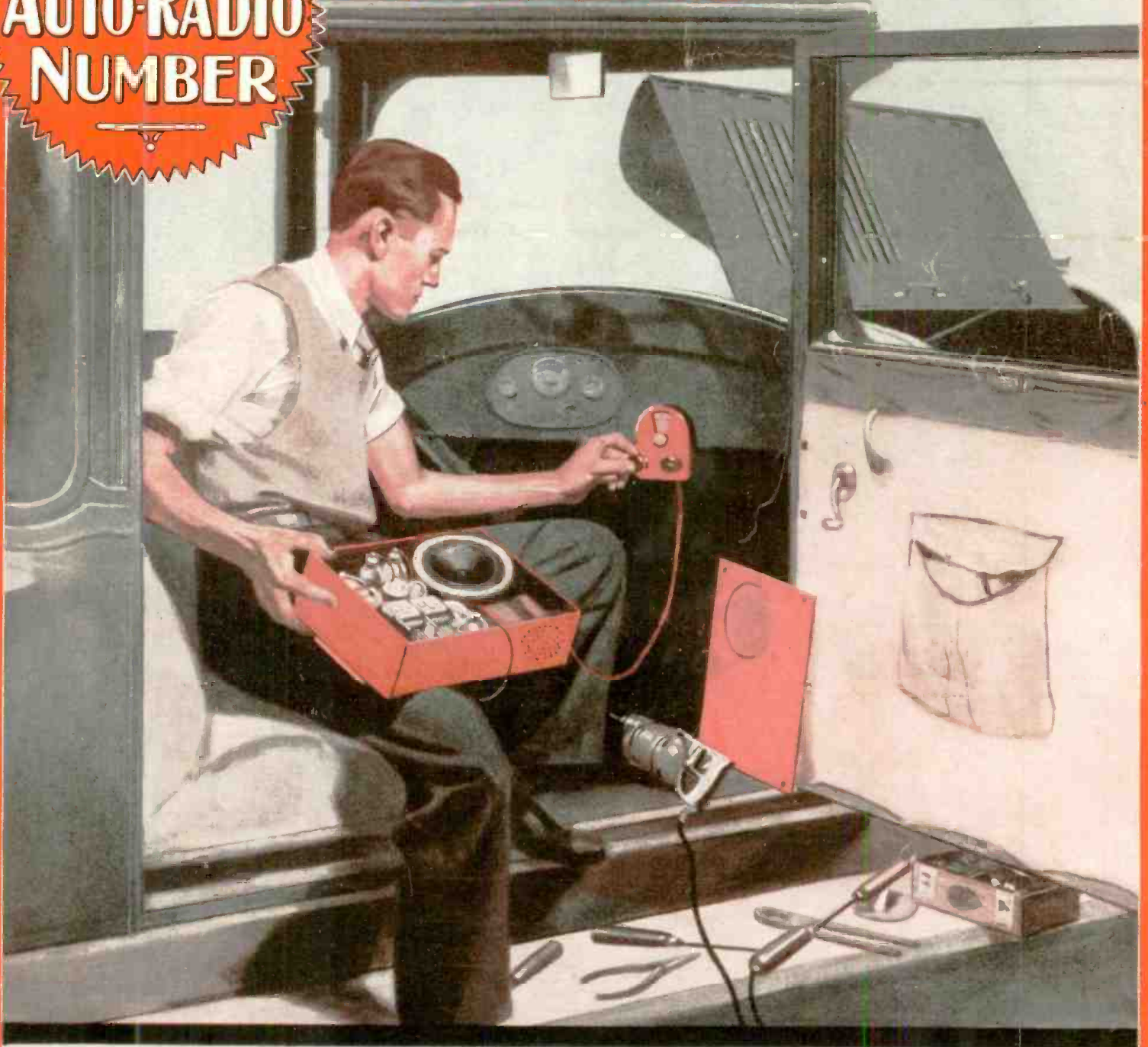

**Modern Auto-Radio Sets and Auto-Radio Equipment—Operating Notes  
A Duplex Inter-Office Call System—Beginner's Page—New DX Page**

# An *Announcement* of Importance

## To Our Readers—

During the past few months many letters have been received from readers of RADIO-CRAFT telling us that they have been unable to procure copies of this publication from their local newsdealer, and it was necessary to either write to us or to travel some distance to buy a copy.

The increasing number of magazine newsdealers throughout the country makes it difficult for us to supply every new dealer immediately with copies of RADIO-CRAFT. Occasionally a month or two passes before he receives first copies. Then on the other hand, very often the dealer carries only one or two copies which he sells quickly. Sometimes it is possible that your dealer does not carry any copies of RADIO-CRAFT.

Whatever may be the case, we ask our readers at this time for their wholehearted cooperation. We are earnestly trying to give you a better magazine each month—to bring you new articles, better illustrations and new writers. At the same time we are anxious to bring you new advertisers whose products you will be interested in buying. And ultimately we are striving to make more people read RADIO-CRAFT each month. At this time you can be of assistance to us by reporting to us the name of your dealer if he cannot supply you and your friends regularly with copies of this magazine. For your convenience a

coupon will be found in the lower lefthand corner—just fill it in—enclose it in an envelope or paste it on a postcard and mail it to us. We shall make every effort to encourage your newsdealer to carry several copies of RADIO-CRAFT every month so that you and your friends can conveniently buy the current issues.

*You are assured of our sincere thanks if you will take only a few moments of your time to do this for us.*

THE PUBLISHERS.

**RADIO-CRAFT**

96-98 PARK PLACE NEW YORK, N. Y.

If you do not want to mutilate the cover of this magazine, you can send us this information in a short letter, or on a sheet of paper.

RADIO-CRAFT,  
96-98 Park Place, New York N. Y.

Gentlemen: I am unable to get my copy of RADIO-CRAFT at my newsdealer. Will you please arrange to have him carry several copies?

My dealer's name is .....

His address is .....

City and State .....

My Name .....

Address .....

City and State .....

R-6



# AT LAST!

## WORLD-FAMOUS COYNE TRAINING IN



# ELECTRICITY

Available For

# HOME STUDY

### NOT The Ordinary Correspondence Course

The 1,000 page COYNE Standard Reference Set, with its more than 1500 illustrations, is NOT the usual correspondence course. It is so arranged that, instead of getting one or two lessons a month from which to answer a few simple questions, you get the whole complete volume at once, so that you can refer to advanced sections and different branches of electrical work at will, going ahead as fast or slow as you please. And the book itself is always valuable for constant reference and review.

### No Previous Experience Needed To Succeed

Advanced education or previous experience is not needed to make a success of COYNE Electrical Training. Everything is given in simple, easily understood language, illustrated thoroughly by photographs and diagrams. If you can read and understand simple English you can learn all about the operation, care, service, repair, etc., of practical electrical equipment from this great book.

### Immediate Profits From This Book!

You will find it possible to learn to do real electrical jobs almost immediately upon receiving your COYNE Standard Reference Set book. There are many excellent opportunities to earn good money from spare time electrical work right in your own neighborhood while you are studying. This is not idle talk—but the actual experience of others no brighter or more able than you. If you have pep and initiative, you ought to be able to make this set pay for itself many times.

The practical, simple, easily understood instruction material that has made COYNE famous for 34 years is NOW—for the first time in history—available for YOU to study AT HOME! Never before has this instruction material been available for any but regularly enrolled resident students and graduates of COYNE. But now, compiled by the entire COYNE staff assisted by many of the world's outstanding electrical firms, this rich store of electrical knowledge is available for you in convenient book form—to study at home.

### FREE CONSULTATION SERVICE INCLUDED

Every owner of this wonderful book—The Standard COYNE Reference Set—will be entitled to the privilege of freely consulting with COYNE Expert Instructors in the solution of any electrical problems that may arise in studying and using this home training set during an entire year's time. This feature alone is worth many times the small price of the book... as testified by hundreds of working electricians—who have made use of this unique service.

### Here's Why I Am Taking This Step!

It means a great deal to me to break a tradition and change a well-established policy after 34 years. That's what I am doing when I offer COYNE Training to you AT HOME, instead of ONLY here in our great shops. But these are unusual times, and have created unusual conditions. Many ambitious men who would be here at COYNE now—preparing themselves for a useful, profitable life work in electricity—cannot come because of financial difficulties. It is my thought that, by offering this COYNE Training to them for home study at ridiculously low prices, they will be able to earn from what they learn, and soon be financially able to come to COYNE later if they decide they still want this superior electrical training that is known the world over for its practicalness and thoroughness. Not that getting this book means the buyer has to come to COYNE... it is simply my hope that the knowledge and earning power gained from this book will inspire you to want the complete training that can come only from attendance at COYNE.

H. C. Lewis, President.



### Don't Delay—Get Started NOW!

This big book of more than a thousand pages—cramped full of practical electrical knowledge illustrated by more than 1500 photographs, diagrams, etc., shows you how to do real electrical jobs of every kind from installing switches and wiring houses to connecting, testing, operating and repairing A. C. and D. C. motors, controllers, generators, and switchboards. Get it AT ONCE—you'll be delighted with the ease and quickness with which you learn and can get to making real money out of spare time electrical work. Send your order on the coupon NOW!

**2<sup>00</sup>**  
WITH ORDER  
\$2 A Month

Until full price of \$12 is paid. Or \$9.75 cash in advance.

## COYNE ELECTRICAL SCHOOLS

500 S. Paulina Street,  
Dept. 63-85,  
**CHICAGO, ILL.**

H. C. Lewis, President,  
COYNE Electrical School,  
500 S. Paulina St.,  
Chicago, Illinois, Dept. 63-85,  
send me the big, 1,000-page COYNE Standard Reference Set, to-  
gether with the Certificate entitling me to  
consultation Service with your experts, until the total price of \$12.00 is paid. (If you pre-  
fer to pay all cash, remit only \$9.75 with this coupon in complete payments.)

NAME \_\_\_\_\_  
ADDRESS \_\_\_\_\_  
TOWN \_\_\_\_\_  
STATE \_\_\_\_\_

(Cash, check or money order) for which I agree to pay \$2 a month. (If you pre-fer to pay all cash, remit only \$9.75 with this coupon in complete payments.)



HUGO GERNSBACK, Editor-in-Chief

LOUIS MARTIN  
Associate Editor

R. D. WASHBURNE  
Technical Editor

## CONTENTS OF THE JUNE, 1933, ISSUE

VOLUME IV NUMBER 12

Editorial: Automobile Radio Sets.....	Hugo Gernsback	711
Automotive Radio—A Boon to Summer Radio.....		712
Auto-Radio Accessories.....		714
A New Duplex Call System.....	Leon J. Littmann	718
Operating Notes.....	Monroe M. Freedman	720
<b>RADIO SERVICE DATA SHEETS:</b>		
No. 91 RCA Victor Model RO-23, 11-Tube All-Wave Superheterodyne.....		722
No. 92 Clarion Model 300.....		723
How to Make the Beginners' Power Crystal Set.....	F. R. Harris	724
Building the Truest "Advance Economy Eight".....	Hubert L. Shortt and Frank Lester	726
Modern Commercial Automotive Receivers.....		727
The DX Listener's Forum.....		744
The Readers' Department.....		745
Information Bureau.....		748
Servicing A.C. Hum.....	Sidney Fishberg	756
Application Note on the 2B7, 6B7, 55, 75, 77, and 85 as Resistance-Coupled A.F. Amplifiers.....		757
RMA Standards.....		759

### IN OUR NEXT FEW ISSUES:

**COPPER-OXIDE RECTIFIERS.** The copper-oxide rectifiers is one of the most useful devices in the modern service kit. We refer to the small, but efficient, rectifiers used with the conventional D.C. meter to make it read A.C. The article to be presented is exceptionally complete: curves showing the efficiency of the device; the changes in its resistance as the current through it is varied; the effects of temperature; and how to use it, are all part of this vital article. It is written in simple, but accurate, language that will appeal to everyone—and by an authority, too. Don't miss this one.

**COLOR RADIO.** We'll let you in on a little secret. You have heard of tone controls, haven't you? Well, a radio set will soon be available in which there is a neat device which allows you to block out the "lows" without hampering the "highs," and vice versa. Not only that, but a spectrum appears which tells you the amount of lows or "highs" you have. It works—we're ahead of our story, now.

RADIO-CRAFT is published monthly, on the fifth of the month preceding that of date; its subscription price is \$2.50 per year. (In Canada and foreign countries, \$3.00 a year to cover additional postage.) Entered at the post office at Mt. Morris, Ill., as second-class matter under the act of March 3, 1879. Trademark and copyright by permission of Gernsback Publications, Inc., 98 Park Place, N. Y. C. Text and illustrations of this magazine are copyright and must not be reproduced without permission of the copyright owners. We are also agents for WONDER STORIES and WONDER STORIES QUARTERLY. Subscription to these magazines may be taken in combination with RADIO-CRAFT at reduced Club rates. Write for information. Copyright 1933. GERNSBACK PUBLICATIONS, INC.

HUGO GERNSBACK, President  
S. GERNSBACK, Treasurer

J. M. HERZBERG, Vice-President  
I. S. MANHEIMER, Secretary

Published by TECHNI-CRAFT PUBLISHING CORPORATION. Publication office: 404 N. Wesley Ave., Mount Morris, Illinois. Editorial and Advertising Office: 96-98 Park Place, New York City. Chicago Advertising Office: 737 North Michigan Avenue, Chicago, Ill. Western Advertising Office: 220 No. Catalina St., Los Angeles, Calif. L. F. McClure, Chicago Advertising Representative. Loyd B. Chappell, Western Advertising Representative.

London Agent: Hachette & Cie., 3 La Belle Sauvage, Ludgate Hill, E.C. 4  
Paris Agent: Hachette & Cie., 111 Rue Reaumur  
Australian Agent: McGill's Agency  
179 Elizabeth St., Melbourne



# Only THE SCOTT 15-550 METER ALL-WAVE Deluxe RADIO

## delivers such Clear, Consistent Year 'Round WORLD-WIDE RECEPTION



This receiver is the crowning achievement of my eight years experience building world's record-breaking superheterodyne receivers. I have no hesitancy in backing it with the strongest guarantee ever placed on a radio.

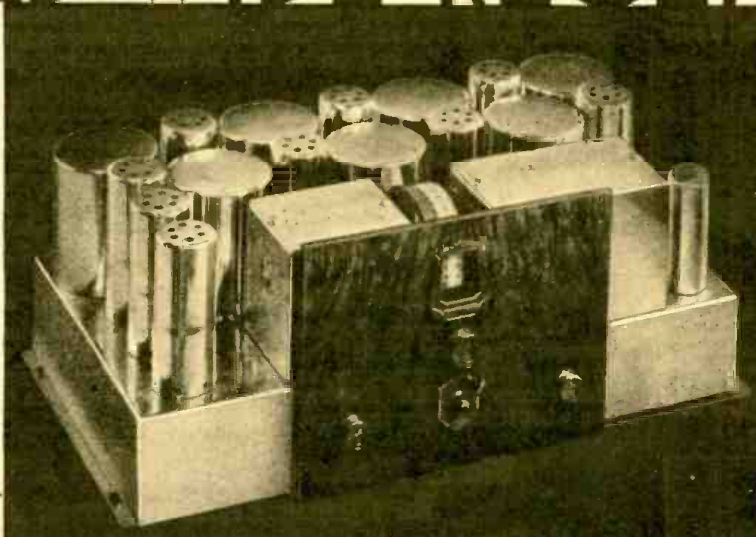

BEAUTIFUL in its chromium-plated finish, the SCOTT ALL-WAVE DeLuxe is as capable as it looks. Embodying every worthy scientific improvement, such as automatic volume control, visual tuning, static suppressor, etc., it is a marvel of careful custom building to most exacting laboratory standards of perfection.

### ITALY

Each day come new letters of enthusiastic praise from owners of SCOTT ALL-WAVE DeLuxe RADIOS. Here are excerpts from a few late ones—on file at

*They Said It Couldn't Be Done  
..but I GUARANTEE It!*

### SPAIN

SCOTT ALL-WAVE DeLuxe owners are more enthusiastic over their receivers than most radio listeners—why not?—they have more to be pleased

### FOREIGN STATIONS LIKE LOCALS

### FRANCE

the Scott Laboratories for inspection by any one. "Rome, England, Germany and Spain come in very good—more than pleased with set—tone is superb," RPH,

The thrill of tuning in foreign short wave stations, as far as 10,000 miles distant, clearly with full loudspeaker volume, consistently the year 'round... plus perfect reception of literally everything on the regular broadcast band on the North American continent! For years a dream... scoffed at as "impossible" by many so-called "experts" even today... yet the SCOTT ALL-WAVE DeLuxe RADIO actually does it—not only in occasional test cases, but regularly—for every owner—under the broadest, soundest guarantee ever placed on a radio set. If you would like to know more about such a sensationally performing record-breaking radio... send for complete details, including PROOFS.

### ENGLAND

over! "Never owned or heard a better, clearer or purer-toned receiver, and this is my 13th all-electric set," RCS, Texas... "France, Italy, Russia and China with very

### GERMANY

Conn. "Best radio I have ever owned—price very reasonable for what it is and will do—have logged Rome, England, France, Spain, Brazil, Germany, Australia," OSJ, Conn. "VK3ME,

### ECUADOR

powerful loudspeaker volume," EB, Indo-China... "Get as far afield as England," GAH, Australia... "Moscow, South America and Pittsburgh fine," EAC, Alaska... "U.S.A.,

### INDO-CHINA

Australia, every time they are on the air—clarity of tone and volume like local," CGB, Conn. "European stations as much 'at my finger tips' as locals," TPB, D. C. "England so that it can be heard all over house—

### ARGENTINE

Canada, Australia, Japan, Indo-China, Siberia, Mexico, France whenever they are on the air," JTM, Hawaii. These and hundreds of other like letters may be seen in our files at any time upon request.

### AUSTRALIA

also Paris and Rome—on grounded 25-foot aerial," WCD, N. J. "Congratulations on a receiver of such extreme sensitivity. Marvelous tone quality." JES, IH,—commercial manager of a great broadcasting station—Reception and recording on phonograph records of every program from VK2ME and VK3ME for an entire year accomplished by Mr. Scott under home reception conditions in Chicago.

If you plan to visit Chicago's  
A CENTURY OF PROGRESS  
be sure to come and inspect our Laboratories,  
to see and to hear these marvelous receivers.

### Mail Coupon NOW

**E. H. SCOTT  
RADIO  
LABORATORIES, INC.**  
4450 RAVENSWOOD AVENUE  
Dept. C63  
CHICAGO, ILLINOIS

E. H. SCOTT RADIO LABORATORIES, INC.  
4450 Ravenswood Ave., Dept. C63 Chicago, Ill.

Send me complete details regarding the SCOTT ALL-WAVE DeLuxe RADIO, including technical data, performance PROOFS, and price quotations.

Name \_\_\_\_\_  
Address \_\_\_\_\_  
Town \_\_\_\_\_ State \_\_\_\_\_



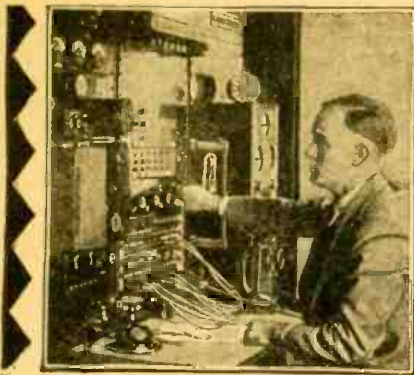

Broadcasting Stations employ trained men continually for jobs paying up to \$5,000 a year.



Police Departments are finding Radio a great aid in their work. Many good jobs have been made in this new field.



Spare time set servicing pays many N.R.I. men \$200 to \$1,000 a year. Full-time men make as much as \$65, \$75, \$100 a week.

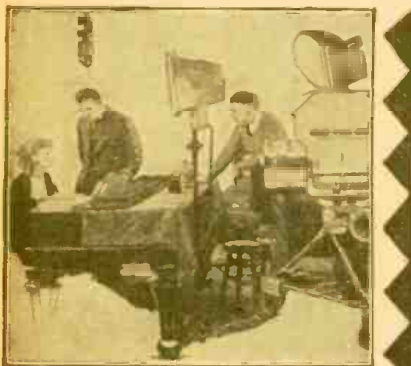

Talking Movies—an invention made possible by Radio—employs many well trained radio men for jobs paying \$75 to \$200 a week.



Television—the coming field of many great opportunities—is covered by my course.

# I WILL TRAIN YOU AT HOME

## Many Make \$50 to \$100 a Week in Radio -- *the Field With a Future*

My book, "Rich Rewards in Radio," gives you full information on the opportunities in Radio and explains how I can train you quickly to become a Radio Expert through my practical Home Study training. It is free. Clip and mail the coupon NOW. Radio's amazing growth has made hundreds of fine jobs which pay \$50, \$60, \$75 and \$100 a week. Many of these jobs may quickly lead to salaries as high as \$125, \$150 and \$200 a week.

### Radio—the Field With a Future

Ever so often a new business is started in this country. You have seen how the men and young men who got into the automobile, motion picture and other industries when they were started had the first chance at the big jobs—the \$5,000, \$10,000 and \$15,000 a year jobs. Radio offers the same chance that made men rich in those businesses. It has already made many men independent and will make many more wealthy in the future. You will be kicking yourself if you pass up this once-in-a-lifetime opportunity for financial independence.

### Many Radio Experts Make \$50 to \$100 a Week

In the short space of a few years 300,000 Radio jobs have been created, and thousands more will be made by its future development. Men with the right training—the kind of training I will give you in the N.R.I. Course—have stepped into Radio at 2 and 3 times their former salaries. Experienced service men as well as beginners praise N.R.I. training for what it has done for them.

### Many Make \$5, \$10, \$15 a Week Extra In Spare Time Almost At Once

My Course is world-famous as the one "that pays for itself." The day you enroll I send you instructions, which you should master quickly, for doing 28 Radio jobs common in most every neighborhood. Throughout your Course I will show you how to do other repair and service jobs on the side for extra money. I will not only show you how to do the jobs but how to get them. I'll give you the plans and ideas that have made \$200 to \$1,000 a year for N.R.I. men in their spare time. G. W. Page, 110 Raleigh Apts., Nashville, Tenn., writes: "I made \$935 in my spare time while taking your Course." My book, "Rich Rewards in Radio," gives many letters from students who earned four, five and six times their tuition fees before they graduated.

### Get Ready Now for Jobs Like These

Broadcasting stations use engineers, operators, station managers and pay up to \$5,000 a year. Radio manufacturers employ testers, inspectors, foremen, engineers, service men, buyers and managers for jobs paying up to \$6,000 a year. Radio dealers and jobbers (there are over 35,000) employ service men, salesmen, buyers, managers and pay up to \$100 a week. Talking pictures pay as much as \$75 to \$200 a week to men with Radio training. There are hundreds of opportunities for you to have a spare-time or full-time Radio business of your own—to be your own boss. I'll show you how to start your own business with practically no capital—how to do it on money made in spare time while learning. My book tells you of other opportunities. Be sure to get it at once. Just clip and mail the coupon.

## I HAVE STARTED MANY IN RADIO AT 2 AND 3 TIMES



**\$400.00  
Each  
Month**

"I spent fifteen years as traveling salesman and was making good money but could see the opportunities in Radio. Believe me, I am not sorry, for I have made more money than ever before. I have made more than \$400 each month and it really was your course that brought me to this. I can't say too much for N.R.I."—J. G. Dahlstead, Radio Sta. KYA, San Francisco, Cal.



**\$800.00  
In Spare  
Time**

"Money could not pay for what I got out of your course. I did not know a single thing about Radio before I enrolled, but I have made \$800 in my spare time, although my work keeps me away from home from 6:00 A.M. to 7:00 P.M. Every word I ever read about your course I have found true."—Milton I. Leiby, Jr., Tipton, Pennsylvania.



**Chief  
Engineer  
Station WOS**

"I have a nice position and am getting a good salary as Chief Engineer of Radio Station WOS. Before entering Radio, my salary was barely \$1,000.00 a year. It is now \$2,400.00 a year. Before entering Radio, my work was, more or less, a drudgery—it is now a pleasure. All of this is the result of the N.R.I. training and study. You got me my first important position."—H. H. Lance, Radio Station WOS, Jefferson City, Missouri.



# TO BE A RADIO EXPERT

**Act Now --- Mail Coupon Below for Free Book of Facts and Proof**

**You Can Learn at Home in Your Spare Time to be a Radio Expert**

Hold your job. There is no need for you to leave home. I will train you quickly and inexpensively during your spare time. You don't have to be a high school or college graduate. My Course is written in a clear, interesting style that most anyone can grasp. I give you practical experience under my 50-50 method of training—one-half from lesson books and one-half from practical experiments with equipment given without extra charge. This unique and unequalled method has been called one of the greatest developments in correspondence Radio training. N.R.I. pioneered and developed it. It makes learning at home easy, fascinating, practical.

**Learn the Secrets of Short Wave, Television, Talking Pictures, Set Servicing, Broadcasting**

I'll give you more training than you need to get a job—I'll give you your choice, and not charge you extra either, of my Advanced Courses on these subjects—(1) Television, (2) Set Servicing and Merchandising, (3) Sound Pictures and Public Address Systems, (4) Broadcasting, Commercial and Ship Radio Stations, (5) Aircraft Radio. Advanced specialized training like this gives you a decided advantage.

**Your Money Back if You are Not Satisfied**

I will give you an agreement in writing, legal and binding upon this Institute, to refund every penny of your money upon completing my Course if you are not satisfied with my Lessons and Instruction Service. The resources of the National Radio Institute, Pioneer and World's Largest Home-Study Radio School, stand behind this agreement.

**Find Out What Radio Offers. Get My Book**

One copy of my valuable 64-page book, "Rich Rewards in Radio," is free to any resident of the U. S. and Canada over 15 years old. It has started hundreds of men and young men on the road to better jobs and a bright future. It has shown hundreds of men who were in blind alley jobs, how to get into easier, more fascinating, better paying work. It tells you where the good Radio jobs are, what they pay, how you can quickly and easily fit yourself to be a Radio Expert. The Coupon will bring you a copy free. Send it at once. Your request does not obligate you in any way. Mail coupon in envelope or paste on post card. ACT NOW.

**J. E. SMITH, President**  
Dept. 3FX, National Radio Institute  
Washington, D. C.

**FORMER PAY**



**Experienced Radio Man Praises N. R. I. Course**

"Before taking your course, I had worked at Radio for over seven years, doing quite a bit of servicing, but I realized that I was in need of better training. From the first lesson on I began to understand points that had had me wondering. The course has taught me what I could not have learned otherwise and I would not take many times the price it has cost me for the knowledge I have gained. In a period of nine months, I have made at least \$3,500."—C. J. Stegner, 28 So. Sandusky St., Delaware, Ohio.

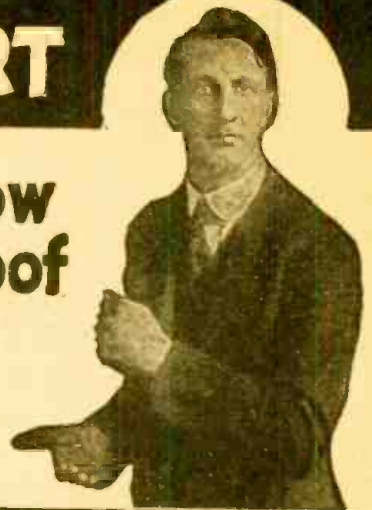

**Sample Lesson FREE**



Mail the coupon today. In addition to my big free book, "Rich Rewards in Radio," I'll send you my new reference book, "Modern Automatic Volume Controls." This text is part of my regular course, and in the past only my students could get it. It covers such subjects as Tuning Indicators; Off-Resonance Muters; Direct and Amplified A.V.C. Delay; Diode Detectors; Servicing A.V.C. systems and other important angles of this interesting subject. Of course the book is right up to the minute, and gives you the information in the famous N.R.I. simplified manner. Mail the coupon today, and take advantage of this very special offer.

**SPECIAL Radio Equipment for Broad Practical Experience Given Without Extra Charge**



My Course is not all theory. I'll show you how to use my special Radio equipment for conducting experiments and building circuits which illustrate important principles used in such well-known sets as Westinghouse, General Electric, Philco, R. C. A., Victor, Majestic and others. You work out with your own hands many of the things you read in our lesson books. This 50-50 method of training makes learning at home easy, interesting, fascinating, intensely practical.

**Clip and mail NOW for FREE INFORMATION**

J. E. SMITH, President,  
National Radio Institute, Dept. 3FX,  
Washington, D. C.

Dear Mr. Smith: Please send me your reference book, "Modern Automatic Volume Controls," and your book, "Rich Rewards in Radio," which points out the opportunities for spare-time and full-time jobs in Radio and your famous 50-50 method of training men to become Radio Experts through home study. I understand that this places me under no obligation. (Please print plainly.)

Name..... Age.....

Address .....

City..... State.....

"8SBX"



# Introducing

# POWERACK

RADIO CHASSIS INC. NEW YORK CITY  
TRADE MARK

MAKES YOUR CAR A POWER PLANT

## The Most Startling and Revolutionary Development in the Automobile and Radio Industries



NEW... REAL ECONOMY... UNIVERSAL APPEAL

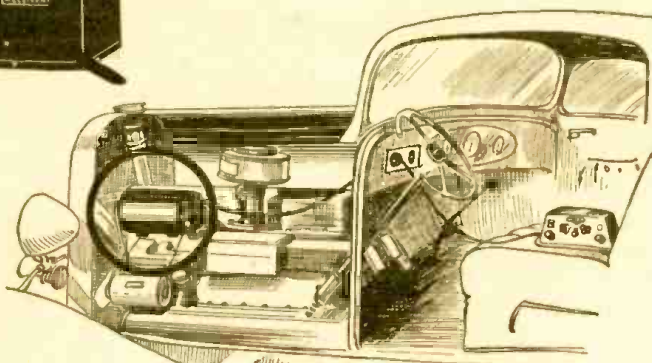

All Units Deliver 110 Volts AC

### MANY USES!

#### CAMP

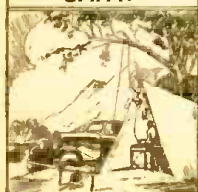

#### MOTOR BOAT

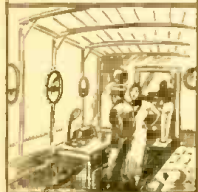

#### AIRPLANE



#### ELECTRIC ADV. SIGNS



#### SPEECH AMPLIFIERS

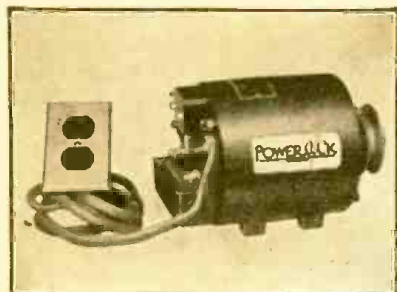

MODEL 21  
50 WATT OUTPUT  
LIST PRICE  
**\$38.50**

MODEL 23  
100 WATT OUTPUT  
LIST PRICE \$46.50

#### GAS ENGINE—GENERATORS WITH FILTERS FOR NOISE ELIMINATION

Model 41—200 Watt Output.....List Price \$ 99.50  
Model 43—300 Watt Output.....List Price 139.50

#### 32 VOLT DYNAMOTORS FOR DELCO SYSTEMS

Model 31—150 Watt Output.....List Price \$79.50  
Model 33—200 Watt Output.....List Price 84.50

There is no battery drain with POWERACK. POWERACK converts the mechanical energy of the running motor into 110 Volts A. C. current. Plug any A. C. or AC-DC receiver into the dashboard outlet and it works as it does in the home... WITH NO DRAIN ON THE BATTERY.

POWERACK has other uses. The 100 watt unit delivers 50 watts for any radio receiver and 50 watts which can be used to run an upholstery vacuum cleaner, portable electric fan, etc. If you get a flat tire on an open country road, plug a portable electric light into the second outlet on the dashboard and fix the flat in comfort and light. For camping purposes, in addition to the operation of a radio, POWERACK will either light two 25 watt bulbs or one 50 watt bulb. Play bridge by regular electric lighting. POWERACK will supply current to light up your summer bungalow. In other words, you have available the same current in your car as you have in your home and all electrical appliances which add comfort in your home will add comfort in your car.

Sold through wholesale distributors only

**RADIO CHASSIS, INC.**

112 W. 18th St. Dept. RC New York City  
EXPORT DEPT.—1457 Broadway, New York City

### ● DELIVERS 110 VOLTS AC!

The universal current for radio and electrical appliances. Voltage constant under variable speeds.

### ● POSITIVELY NO BATTERY DRAIN!

Unit in no way connected to, or draws absolutely no current from car battery.

### ● RUGGED CONSTRUCTION!

No commutator or slip ring. Ball bearing rotor.

### ● HOME RADIO IN YOUR CAR!

Plug any 110 Volt AC or AC-DC receiver into dashboard outlet, and connect to car antenna. Additional outlet in dashboard permits added uses of electricity.

### ● EASY INSTALLATION!

Complete unit can be installed by the average radio mechanic in one-half hour. No unit cutouts, no complicated drilling.

### ● FOOLPROOF—NO UPKEEP!

No attention or care needed. Ball bearing rotor eliminates oiling. No wear or tear on car in any manner.

### ● ELECTRICAL APPLIANCES!

Upholstery vacuum cleaner, portable fan, cigarette lighter, camp lighting.

### Clip the Coupon

Add this fast-moving useful product to your summer line. Full territorial protection to dealers.

PRICES WEST OF ROCKIES SLIGHTLY HIGHER

Please send me full details on the Powerack and merchandising plan.  
Name \_\_\_\_\_  
Address \_\_\_\_\_  
My jobber \_\_\_\_\_





"Takes the Resistance Out of Radio"

## AUTOMOBILE RADIO SETS

An Editorial by HUGO GERNSBACK

**F**ROM the purely experimental stage, automobile radio sets have emerged during the past two years into a standard product.

Formerly it was necessary to rip practically the entire car apart in order to install a set in a car. Starting with the top of the car wherein you had to place an aerial, additional work had to be done to install a separate loudspeaker; a good deal of fussing was also necessary, and even then the results were not any too good. Reception from local stations was satisfactory, but on the road, fifty or a hundred miles distant from the nearest broadcast station, results were poor.

But conditions have changed for the better, and the sets now being put out have been engineered in a manner satisfactory to all. A number of car manufacturers have cooperated with the radio industry so that practically all the new cars coming through now have aeri-als installed. While such aeri-als help a great deal, they are no longer absolutely necessary because with the high gain sets, which we now have, a small, compact aerial hung underneath the chassis is all that is needed to give excellent results.

The more up-to-date automobile radio sets for 1933 are engineered along the "unit idea" where everything is contained in one block, or box. A complete radio set with all its tubes, tuning controls, loudspeaker, "B" eliminator, etc., are all placed in the self-same container. Some of these sets do not require any remote control cable, but may be tuned directly by means of control knobs which extend from the box. This may be said to be the ultimate, and no doubt such sets will become increasingly popular as time goes on because they are so easy to install and because very little extra wiring is needed.

Of course, the usual spark plug suppressors must still be used in order to get noiseless reception, and wire connections still have to be made to the "A" battery; but these are minor considerations.

Of interest to the radio industry is the fact that there are still many millions of automobiles in this country which are not equipped with radio, and which are excellent prospects for automobile sets.

Service Men, particularly, have a young gold mine in automobiles not radio-equipped in their neighborhood and communities; and, very frequently, a demonstration is all

that is needed to make a sale. People who use their cars a great deal when traveling between cities and in the country are always impressed by an automobile radio set because it keeps them in touch with the news and gives them radio programs to while away their time.

Those Service Men who own cars should not forego the opportunity to install a set in their own car for demonstration purposes. Once a car owner gets the radio automobile bug, he will not rest until he has a set installed.

Automobile sets today are made in a wide variety of price ranges to fit almost any pocketbook. There are, however, certain things to be said about price. Remember, an automobile set is not a set such as is used in the home. The auto set undergoes terrific punishment due to the constant jarring it receives. Only a well engineered set will stand up indefinitely under such punishment. Usually, the very low priced sets do not stand up, as the parts are apt to jar loose, making the set inoperative. These are self-evident considerations which are frequently overlooked, and there is nothing that will give the radio trade a worse black eye than to install one of these cheap sets; then, when its owner denounces the radio, he will perhaps be the direct cause of killing a dozen sales which would have been made if the right set had been sold in the first place.

With the new and improved radio tubes which are far more sensitive and give greater amplification, it is possible to build a set with fewer tubes and still get better reception than you could get even a few months ago with almost twice as many tubes; the trend this year is distinctly for less tubes.

There are more good automobile sets being put out at the present time than at any other time in the past. Indeed, automobile radio threatens to become an industry by itself, simply because the essential requirements are different.

Already, we have the phenomena of special automobile radio installation men and Service Men who devote themselves entirely to this type of work.

Thousands of Service Men this year will cash in on the demand by the general public for automobile radio sets, and this demand is now increasing and will continue to do so for some years. Alert Service Men will know what to do to cash in on this lucrative business.

# AUTOMOTIVE RADIO-- A BOON TO SUMMER RADIO

**A**UTO radio, for the past several years a more or less neglected orphan, promises to come into its own this summer. Radio manufacturers and automobile manufacturers have gotten together and both intend to promote sales as never before. This is good news for Service Men everywhere, as it means installation and service work during the hot summer months, when the radio business otherwise is usually pretty weak.

This merchandising effort is being directed along two paths. Several of the larger auto firms are having auto radio sets built for them by radio manufacturers, and will handle them as accessories, just as they now handle trunk racks, heaters, and the like. The nationally known radio companies will exploit their own trade-marked sets through their regular jobber and dealer channels. Considerable money has been appropriated for advertising, publicity, and general ballyhoo to arouse the auto-owning public to the desirability of auto radio receivers.

In order that Service Men may acquaint themselves with the new receivers that will be featured this season, RADIO-CRAFT is presenting herewith a compilation of valuable data supplied by representative manufacturers. At the time this issue went to press a number of firms had not yet completed their new sets and could not meet our dead line; however, their products will be described in subsequent issues.

A combination of fortunate circumstances seems to assure a highly successful season.

First and foremost, we now have technically perfected receivers that can be demonstrated, sold and installed with complete confidence—sets that will *stay* sold without making the dealer lose his profit in needless service work. Their sensitivity, selectivity, tone quality, and economy, no longer call for apologies or explanations, as, sadly enough, previous sets did call for.

Auto radio has benefited by the recent avalanche of new tubes to a greater extent than any other phase of the radio business. While there is no excuse whatsoever for some of the latest A.C. tubes, the new battery types fill a very pressing need. No longer do set designers find it necessary to use heavy drain A.C. tubes that run down the car's battery and overwork the charging generator; now they can and do produce sets that draw a total of only six amperes or so. The advances made in economical audio output tubes are particularly noteworthy; the output of many 1933 auto sets is fully as good, and in some cases

even better, than the output of many A.C. house sets. Full, rounded tones and perfectly understandable speech are now obtainable; gone are the tinny music and muffled announcements that characterized auto sets of only a year or two ago.

The limitations of small, partially shielded car aerials have been overcome to a considerable degree by the almost universal use of extremely high-gain superheterodyne circuits, with stable oscillators that stay put and don't wander off tune every time the car hits a bump. This increased sensitivity is of particular importance in remote districts, where the nearest stations are likely to be hundreds of miles away. Previously T.R.F. receivers have proved very unsatisfactory in these areas, where the pleasures of auto radio are most desired.

Improved methods of automatic volume control, borrowed from large-set practice, also contribute much toward customer satisfaction.

## Recent Trends

Probably the greatest single improvement in auto radio installation is represented by the many new "B" power units on the market. In the early auto sets "B" batteries were a constant source of aggravation, simply because dry cells could not stand the temperature extremes of auto service. The new units, of both the vibrator and dynamotor types, are not affected by heat or cold and are thoroughly reliable. They work on the car's storage battery and suffer no de-



The Queens automotive-radio shop of Joe Kiss of New York. It is interesting to note that this store is for the exclusive installation and service of auto-radio equipment. Is it a paying business? If you should ask Mr. Kiss, he would say, "Decidedly, yes!"

terioration of any kind when not in use.

The general trend in overall auto radio design is toward unification. The mechanical difficulties of installing three or four separate units, such as control panel, receiver proper, loudspeaker, and "B" unit, have made engineers lean toward the single-box idea, or at least an approximation of it. A good many sets have at least the "B" unit in the same container as the chassis; others include the loudspeaker, and still others the controls as well. With some single-case sets, the user has the option of steering column control, which is by far the most popular type.

The receiver units themselves are intended in most cases for mounting under the instrument board, or, in the absence of sufficient space there, on the engine bulkhead. In many cars a convenient place is under the front or rear floorboards. With a set in either of the last two positions, the loudspeaker is, of course, a separate unit, and is invariably placed under the dash. With a large variety of sets to



choose from, it is now possible to equip *any* car, from an Austin to a 16-cylinder Cadillac.

Built-in aerials in many new cars greatly simplify the installation job. For cars not so equipped, there are numerous roof top and under-car antennas, usually sold as an accessory to the set itself.

#### Auto Radio and the Service Man

When the possibilities of auto radio first became evident, about four years ago, radio executives were very much concerned about the best method of handling sales and service. Should radio dealers and their Service Men be trained in auto technique, or auto dealers and their shop men trained in radio practices? It was felt at first that the mechanical facilities of the auto shop or service station would be necessary for proper installation and servicing, but with the disappearance of the early makeshift sets and the development of compact units this situation has changed. Today, auto radio is being handled mostly by radio people, because the sales and service problems are decidedly more radio than automotive in nature. After all, the ignition and lighting system of an automobile is kindergarten stuff compared to the intricacies of radio circuits, and any intelligent radio Service Man can read up all he has to know about ignition in about three evenings. His main problem is to develop a monkey-like double jointedness, so that he can wrap himself around a steering column and work upside down!

In the larger cities, auto radio has already become enough of a business to support auto radio specialists—men who handle auto radio and nothing else. As a matter of cold fact, auto radio is a much cleaner and more profitable business than

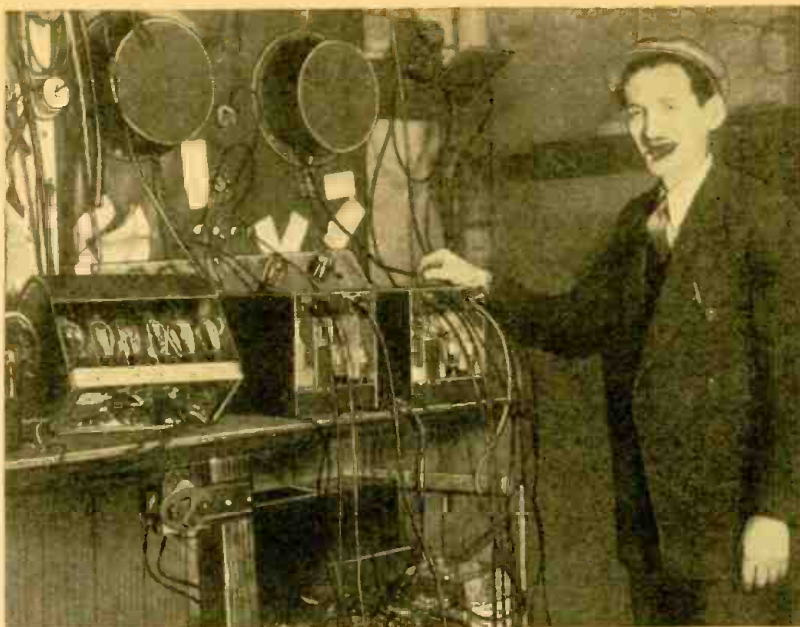

Joe Kiss and his test bench. Our photographer caught Mr. Kiss with this characteristic smile which, no doubt, indicates that "business is good."

Amid the silence pervading the present radio conditions there looms an opportunity for business rivaled only by the radio boom of '22-'28—Automotive Radio.

This statement is not pure philosophical speculation; but is based on the campaign at present being initiated by the leading manufacturers of radio receivers. Large firms that heretofore produced only "home" receivers are now entering this lucrative field with full force.

Mr. Service Man, here is THE opportunity to make money this summer.



"One of the boys" at the Queens store of Joe Kiss. We actually caught this boy installing the set as we came along. How about you pushing automotive radio, Mr. Service Man?

ordinary home radio for two excellent reasons: first, the average selling price of an auto set, installed, is in the neighborhood of fifty dollars, or fully twice as much as the cigar-box midgets that represent most of the across-the-counter sales these lean days; and second, owners of automobiles are rated as much more generous spenders than non-owners. Then again, auto radio has not yet been afflicted with the blight of suicidal price cutting and lowering of production standards, and is not likely to be so affected for some time to come. The point is, that a manufacturer can get away with an extremely cheap house set because it receives little abuse, but cannot possibly succeed with a cheap auto set because of the terrific mechanical punishment it must endure.

The auto radio specialists usually maintain a store on a heavily traveled street, and either have an inside workroom of their own or make use of a nearby garage. The idea is to get away from street curb installations, as much better work can be done indoors, and an inside shop looks more impressive to the customer anyway.

The photographs on this page illustrate a typical auto-radio business in New York City. Mr. Kiss, owner of the firm, has specialized in auto-radio for years, and now operates two stores: one in the heart of the business district of New York, and the other in Queens, a suburb of New York.

The Queens store is a recent addition, made possible by good business. He specializes in Philco, but services all makes. His test bench is simple—it is not complicated by extensive measuring apparatus.

As stated in another section, as emphasized again and again, auto radio is the salvation of Service Men.



# AUTO-RADIO ACCESSORIES

## CARTER AUTO GENEMOTOR

THE Carter Genemotor Corporation has now available a dynamotor suitable for use in automobiles for the elimination of "B" batteries for the operation of auto sets. It operates under the well-known dynamotor principle and delivers 180 volts D.C. with a tap at 90 volts; on Genemotors for 135 volts maximum, the tap is usually taken at 67½ volts. This tap voltage may be varied in cases where the required intermediate voltage is different from those given previously.

In view of the fact that this machine requires no oiling and no adjustments of any kind, very little, if any, servicing will be required. Space required: 4½x6 ins.; weight, 13 pounds, available for use from 6, 12, 32, or 110 volts D.C. They are also made in a wide variety of power ratings.

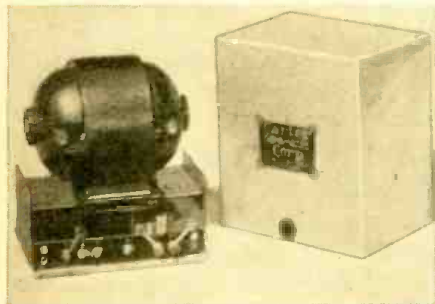

## CENTRALAB SUPPRESSOR KIT

THE Central Radio Laboratories now have available a kit of ignition noise suppressor resistors suitable for all types of cars. These suppressors are specially designed for low internal capacitance, thereby insuring constant resistance over a very wide frequency band. The resistance material and ceramic jacket are baked together as one solid rod at 2,700 degrees. At high frequencies the resistance of these units increase considerably so that Centralab suppressors usually have lower values than are generally used: Suppressors are rated at their D.C. value.

These units are pictured here and are made in 8,000, 15,000, 25,000, and 50,000 ohms each.



## COAST-TO-COAST AMPLIFIERS

THE Coast-To-Coast Radio Corporation announces two new amplifiers suitable for auto use. That illustrated below is of the class A type and is designed for use with the new type 2A3 tubes, and delivers an undistorted output of 20 watts. A feature is the fact that it operates directly from the storage battery of the car—a generator being mounted directly on the amplifier base as an integral part of the equipment. A.C. operation is also provided. The battery drain is 14 amps. Uses one 37 feeding two 37's in push-pull, which feeds two 2A3's.

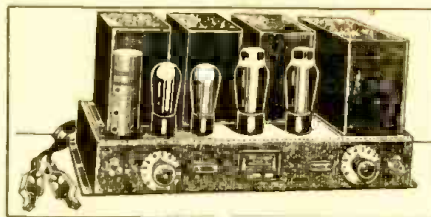

The class B series of amplifiers is also illustrated here. This unit is designed for use with either two or four type 79 tubes, at will; the changeover being affected by means of a switching arrangement. Thus, either 11 or 22 watts output may be obtained. When the output is 11 watts, the current drain from the storage battery—the MG is also included in the amplifier—is 5.8 amperes; with 22 watts output, the drain is 11.5 amps. Uses one 37 feeding two 89's feeding the 79's.

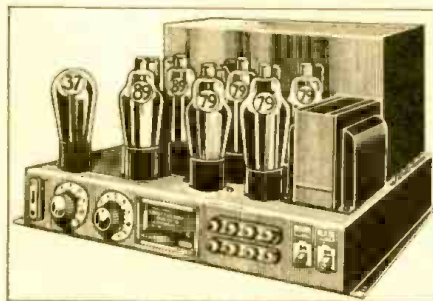

## EMERSON "B" UNIT

THE Emerson "B" power unit of a dynamotor type, having a sealed filter pack mounted on steel end-plates, measuring 6½x4½x7½ inches, has been made available through the Emerson Electric Mfg. Co., Inc. This unit may be used on sets which obtain their "C" bias from "B—" to ground or on sets which have the "B—" grounded. The machine is rated at 180 volts, 40 milliamperes, and draws 2½ amperes

at 6.3 volts. This unit has two armature windings which rotate in a common field. The field coil, of course, is connected across the low-voltage winding.

A 90-volt tap is provided for receivers requiring this voltage. This tap is secured by connecting 15,000- and 20,000-ohm resistors in series across the output of the unit; the 90-volt tap connects to the junction of these two resistors. A 6 mf. condenser is used across the high voltage terminals, as shown in the schematic here. A 2 mf. condenser is disconnected from "B—" to ground and a 1 mf. condenser from "A+" to "A-." The unit should be lubricated but once a year using a medium weight mineral oil, such as a light automobile engine oil.

Efficiency, output voltage, and current drain curves are also shown.

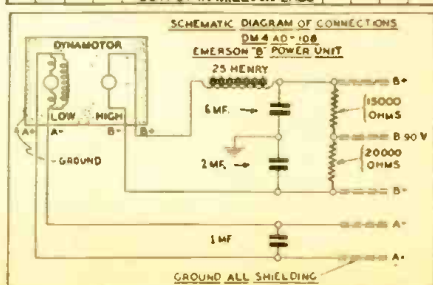
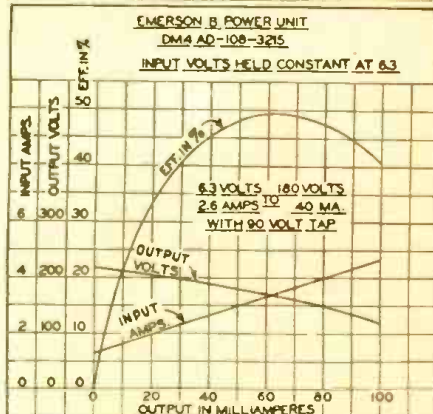



### EVEREADY AUTO "B" BATTERY

NATIONAL Carbon Company's special auto radio battery (No. 796) embodies many features which have been built into it to meet the hard service that auto batteries are required to withstand. The use of the special resilient compound for filling the space between cells, as well as a special cell and a paraffin exterior, results in a battery sufficiently shock proof and moisture resisting to withstand the extreme conditions which will probably be encountered in automobile use.



### HAWLEY LOUDSPEAKER CASE

SINCE the advent of auto radio, a demand has arisen for a suitable housing for loudspeakers used in auto receivers. The usual type of wood or metal cases either have mechanical or acoustical disadvantages which limit their application.

The Hawley loudspeaker case is of special molded material, having excellent acoustical advantages. It is of one piece construction, and the front is provided with a metal grille and a dust proof grille cloth. It is designed for the mounting of standard speakers, using the single stud or similar method of attachment to the dash.



### IRC SUPPRESSORS

IGNITION noise suppressors suitable for all types of cars have been made available through the International Resistance Company. They are especially valuable in that they are able to withstand severe cold, intense heat,

grease deposits, steam, and severe vibration, without having their characteristics altered appreciably.

Suppressor terminals are of one-piece construction, locked and keyed into position by casting them into metal; there is no riveting, no cement or solder, no loose springs to vibrate. They are also moisture proof. Electrical contact is made directly from the one-piece terminal to the resistor element. A change of temperature from 25 to 125 degrees will cause a maximum change of resistance of 4%; its capacity between terminals is .5-mmf.

Three types are available: the type MD spark plug suppressor; type MD distributor suppressor; and type MC cable suppressor.

Kits are available for 4-, 6-, and 8-cylinder cars.

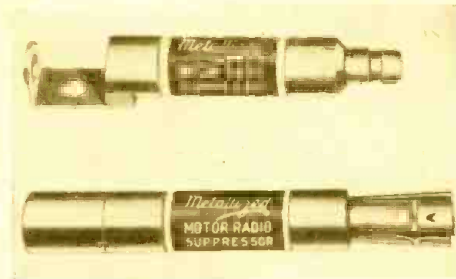

### MALLORY ELKONODE

THE Mallory self-rectifying Elkonode is a device which, within itself, sets up the essentially alternating current and rectifies it at the same time, thus eliminating the cost of the rectifying tube and other parts usually required with the more conventional D.C. to A.C. converters. The construction is such that it permits a design which is silent and which greatly reduces the over-all dimensions of the unit. A complete filter system is incorporated, as shown in the schematic diagram here. There are five different types of Elkonodes in different ratings: A chart showing the use to which each may be put is also shown.

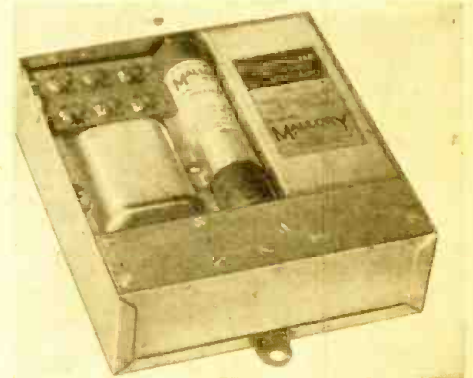

Elkonode and Eliminator Type	Volts Output	FOR RECEIVERS REQUIRING THE FOLLOWING CURRENT IN MILLIAMPERES IN THE "B" MINUS LEAD AT 200 V. ON SIGNAL		Elkonode Rated Output, Watts	Storage Battery Drain in Amps.
		Without Voltage Divider in Elim.	With 2 ma. (100,000 Ohm) Voltage Divider in Elim.		
10	200	40-45	38-43	8.4	2.1
11	200	35-40	33-38	7.4	1.9
12	200	30-35	28-33	6.4	1.6
13	200	25-30	23-28	5.4	1.4
14	200	20-25	18-23	4.4	1.2

A chart indicating the use to which the five different models of Elkonodes may be put. Of particular importance is the storage battery drain, shown in the right-hand column.

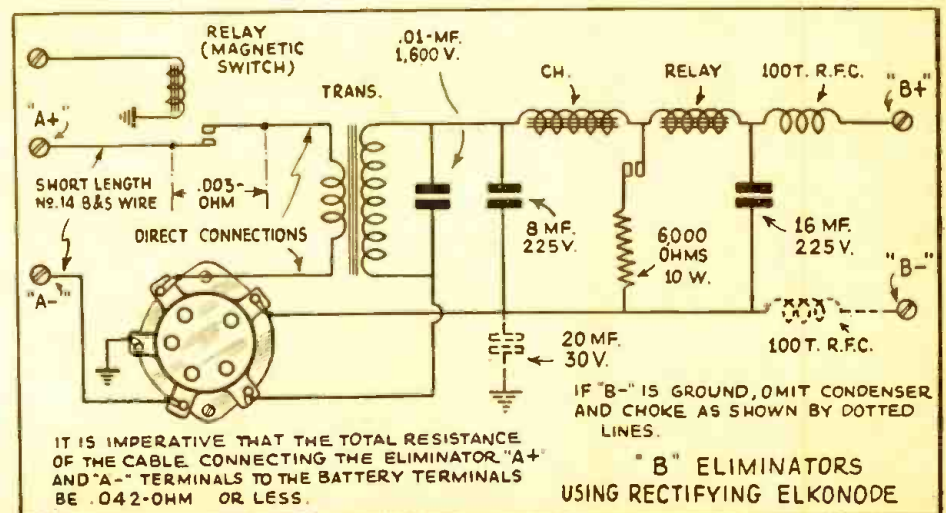

Schematic circuit of the Elkonode described in the text. This unit is self-rectifying—no rectifier tube is used. This method accounts for the high efficiency of this unit.



## OAK "B" ELIMINATOR

A PHOTOGRAPH and a schematic diagram of the new "B" eliminator produced by the Oak Manufacturing Company are shown. The type 180 eliminator has an output of 180 volts at 40 ma. when excited from a 6-volt D.C. source; under these conditions, it draws 2.3 amperes. The eliminator is provided with intermediate taps. The eliminator is equipped with a dual vibrator, feeding a push-pull primary circuit, giving a true alternating current input to an 84 rectifier. The efficiency of this unit is approximately 60% and secures its excitation from the leakage flux.



OAK MFG. CO.

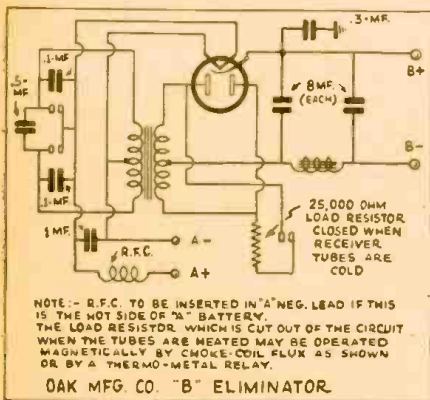

## OHIOHM SUPPRESSORS

THE Ohio Carbon Company has available a set of ignition noise suppressor kits designed specifically for auto radio use. The results of an interesting test conducted by Ohiohm show that suppressors installed in cars and run for over 100,000 miles have stayed within 5% of their original resistance when installed. These units are avail-



able, of course, in kit form as follows: Set No. 74 for 4 cylinder cars; set No. 74F, specially designed for Ford model A cars; set No. 76 for 6 cylinder cars; set No. 78, for 8 cylinder cars; and set No. 78F for 8 cylinder, model V-8 Fords. An illustration of one of these units is shown here.

## PIONEER GEN-E-MOTOR

THE Pioneer Gen-E-Motor Corporation has available various dynamotors suitable for use in auto receivers. The "B" unit, shown here, is 3 3/8 inches high, 5 3/4 inches wide, and 5 3/8 inches long. A filter system is included as part of the equipment. This unit is similar to the previous Pioneer Gen-E-Motor described in RADIO-CRAFT, except that the casing has been redesigned, resulting in an efficiency of better than 50%.



## POSTAL ELIMINATOR

THE Electronic Laboratories, Inc., announce a new auto "B" eliminator—distributed by Postal Radio Corp.—of the vibrator type using a self-contained mercury-vapor rectifier. Features of the unit include the following: a full-wave interrupter and rectifier arrangement; good regulation, better than 80 per cent; more than 50 per cent efficiency; automatic load-delay relay; is independent of battery polarity; adjustable voltage; is noiseless in use.

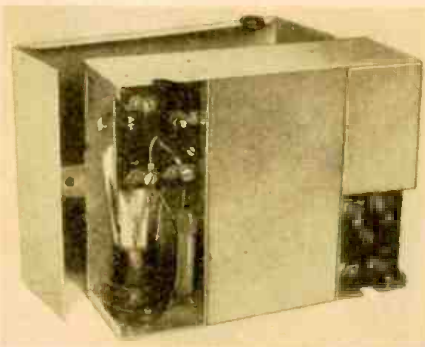

## RADIO CHASSIS "POWER PACK"

"POWER PACK" is a unit measuring 6x6 1/2 x 6 1/2 ins. which, when coupled to the engine of the car, delivers 110 volts A.C. It is usually mounted at the head of the motor in such a position where a grooved wheel (see photograph) mounted on the power pack, is rotated by the same belt which turns over the armature of the charging generator of the car. This belt is rotated

from the fly-wheel of the motor. The field excitation of this unit is taken directly from the low side of the charging generator of the car. Thus, it does not draw any current from the car storage battery. A two-way outlet appears on the dash-board to facilitate tapping the output of the power pack. Of course, this unit is not confined to automobile use, but it may also be used with the gasoline motor on yacht or motor-boat and may be wind-driven for use on airplanes. By means of a special motor, also available, this unit may operate from 32-volt Delco systems.

The unit is available in various sizes, depending upon the use to which it is to be put.

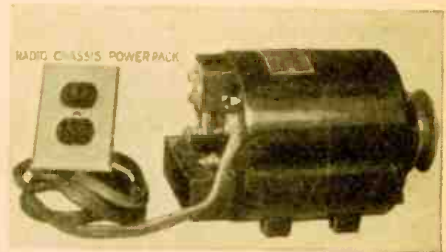

## UNITED SCIENTIFIC CONTROL BOX

THE United Scientific Laboratories, Inc., have available a steering post remote control box suitable for tuning receivers from the driver's seat when the receiver is located elsewhere in the car. The features of this receiver are: a key lock switch and volume control which prevents tampering with battery; an accurately calibrated tuning scale, permitting "hair line" adjustment through a system of gears; an illuminated dial; a drive shaft—an ingeniously designed cable, having a minimum of slack or back lash; a coin embossed old bronze escutcheon; and, of course, a control housing. Two

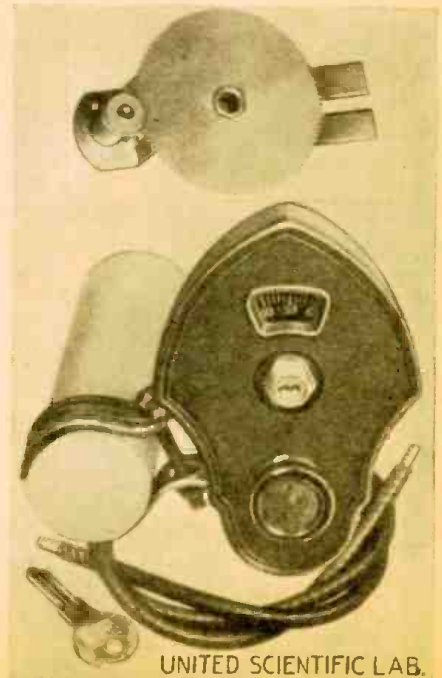

UNITED SCIENTIFIC LAB.



units are available: the type L control is a single cable drive control for tuning variable condensers. A volume control functions as a combination key lock switch and volume control. Type R unit has one cable for tuning adjustment and another cable operates by means of the key switch attached to the combination switch and volume control which is an integral part of the receiver.

A photograph is shown.

### UNIVERSAL BATTERY CONVERTER

TWO models of battery converters have been announced by the Universal Microphone Company for operation by storage batteries and designed to supply 110 volts A.C. The model 60 will operate from 6 volts D.C., has a 60-watt output, and a battery consumption of 90 watts (6 volts at 15 amperes). This unit is recommended for operation of a 3-stage push-pull amplifier using type 45 or 47 tubes, or a smaller amplifier with a turntable. The model 150 device is designed to operate from 12 volts D.C. and is capable of delivering 150 watts at a battery consumption of 216 watts.

This device consists essentially of a D.C. motor, operating an interrupter which is connected in series with the storage battery line. The interrupter voltage is applied to a transformer which in turn delivers 110 volts A.C. output.



### WARD AUTO-RADIO EQUIPMENT

THE Harry Ward Company is producing several auto-radio accessories. Ignition noise suppressor units include the conventional resistors and condensers. There are four types of suppressors: the model C, which fastens to the spark plug in either a vertical or horizontal position; the Model L, for use on the distributor and coil of all cars; the Model R, suitable for Buick and Willys-Knights; and the Model K, which screws onto the head of spark plugs. The condenser in the kit is specially designed for auto-radio use.

Seven types of car antennas are made to suit either the car or the pocketbook: the Groundpick, Companion, Rooftenna, Splitenna, Axletenna, and the Comptenna. A complete line of resistors suitable for construction or replacement purposes are also manufactured, as are volume controls.

## LOCATION OF CONTROL BOX AND SPEAKER \*\*

	Control Unit		Antenna Equipped	Speaker Unit		Left
	Steering Column Parallel	Across		Steering Column	Bulkhead Right	
Pierce-Arrow.....	Yes	Yes	Yes	Yes	Yes	Yes
Ford.....		Yes	No	No	Yes	Yes
Dodge.....	Yes	Yes	Yes	*	Yes	Yes
Plymouth.....	Yes	Yes	Yes	No	Yes	Yes
Stutz.....	Yes	Yes	Yes	No	Yes	Yes
Hudson.....		Yes	No	Yes	Yes	Yes
Essex.....		Yes	No	Yes	Yes	Yes
DeSoto.....	Yes	Yes	Yes	*	Yes	No
Auburn.....	Yes	Yes	No	Yes	Yes	No
Pontiac.....		Yes	No	No	Yes	No
Oldsmobile.....		Yes	No	Yes	Yes	Yes
Chevrolet.....		Yes	No	*	Yes	Yes
Buick.....		Yes	No	Yes	Yes	Yes
Graham.....		Yes	No	No	Yes	No
Franklin.....		Yes	Yes	No	Yes	No
Willys.....		Yes	No	No	Yes	No
Studebaker (Commander).....		Yes	Yes	Yes	Yes	Yes
Studebaker (President).....		Yes	Yes	Yes	Yes	Yes
Nash.....		Yes	Yes	No	No	Yes
Packard.....		*	No	No	Yes	No

\*The list assumes that nothing is to be moved in the car. However, in the Chevrolet, the speaker chassis may be mounted on the steering column by lengthening the free wheeling adjustment. In most cases this adjustment will probably be made. In the Dodge and DeSoto, steering column mounting of the speaker chassis may be accomplished, providing the left hand cowl ventilator is not to be used. The following cars have glove compartments available which may be used to house the control unit, if desired: Franklin, Buick, Cadillac, LaSalle, Marmon, Stutz, and Nash.

\*\*Courtesy, Zenith Radio Corp.

## READERS' VOTING BLANK

THE editors are anxious to give you only the sort of articles you wish. It has always been our policy to publish such material which our readers demand most.

Please tear out this voting blank, paste it on a postal card and send it to us properly filled in. You need not sign your name if you do not wish

to do so.

This will give us an exact idea of the sort of articles in which you are interested. Naturally, the majority will decide.

In case you do not wish to mutilate the magazine, you may copy the blank on a sheet of paper.

PLEASE DO THIS NOW.

Yes	Departments Being Voted Upon	No.
<input type="checkbox"/>	—Service Equipment Construction.....	<input type="checkbox"/>
<input type="checkbox"/>	—Car-Radio Service Data.....	<input type="checkbox"/>
<input type="checkbox"/>	—Electro-Musical Instruments.....	<input type="checkbox"/>
<input type="checkbox"/>	—Radio Service Data Sheets.....	<input type="checkbox"/>
<input type="checkbox"/>	—Information Bureau.....	<input type="checkbox"/>
<input type="checkbox"/>	—New Radio Tubes.....	<input type="checkbox"/>
<input type="checkbox"/>	—Radio Set Construction.....	<input type="checkbox"/>
<input type="checkbox"/>	—Operating Notes.....	<input type="checkbox"/>
<input type="checkbox"/>	—The Radio Beginner.....	<input type="checkbox"/>
<input type="checkbox"/>	—Latest Radio Equipment.....	<input type="checkbox"/>
<input type="checkbox"/>	—The DX Listener's Forum.....	<input type="checkbox"/>
<input type="checkbox"/>	—Broadcast Stations of the U. S.....	<input type="checkbox"/>
<input type="checkbox"/>	—The Readers' Department.....	<input type="checkbox"/>
<input type="checkbox"/>	—Public Address Apparatus.....	<input type="checkbox"/>
<input type="checkbox"/>	—Quasi-Optical Home Experiments.....	<input type="checkbox"/>
Suggestions.....		
Name.....		
Address.....		
City and State.....		
(Clearly print or typewrite name and address)		

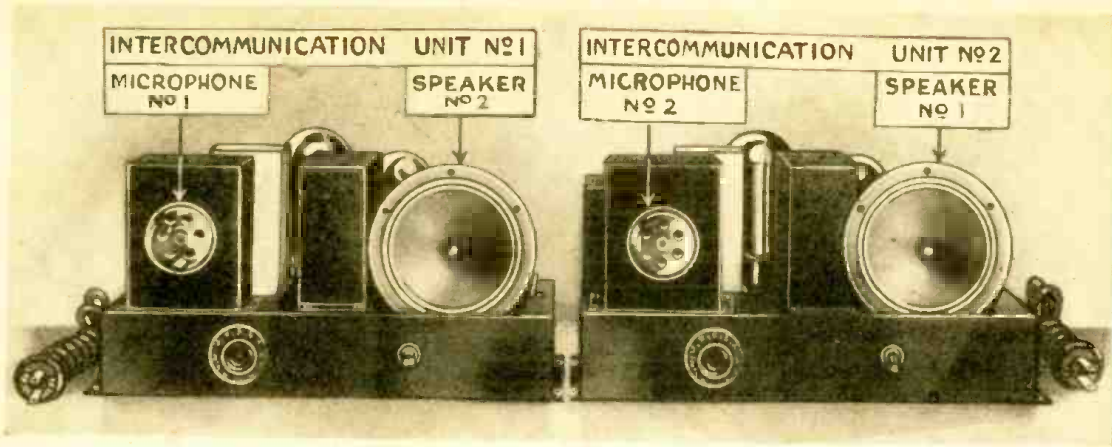

Fig. A  
A view of the inter-office communication system, complete. Station No. 1 is at the left and station No. 2 is shown to the right.

# A NEW DUPLEX CALL SYSTEM

A description of an inter-office communication system permitting uninterrupted two-way communication. It is completely self-contained, permits immediate operation, and is A.C. operated. A novel development in communication service.

LEON J. LITTMANN, E.E.\*



Fig. B  
A panel view of the system installed in a cabinet. Note the controls.

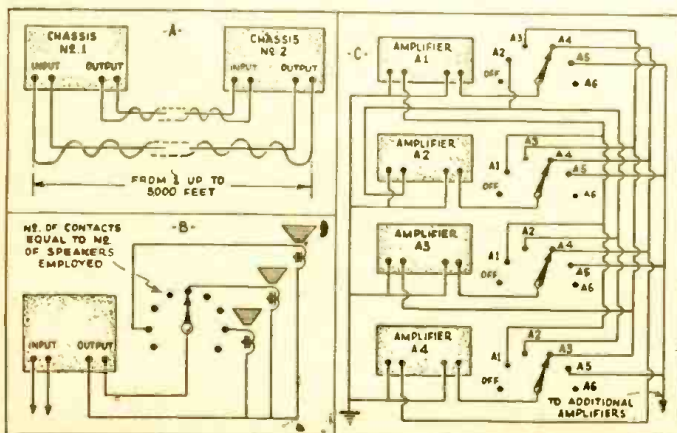

Fig. 1  
A schematic showing the inter-connections of the system.

THE system herein described opens an interesting and remunerative field for the enterprising radio and public-address man, Service Man, dealer, or for any novice or salesman. It is a complete two-way inter-communication system intended primarily for 110 volt, A.C. operation, but it may be easily adapted for D.C., battery, or motor-generator operation. This system has many new and outstanding features, and it is described in detail to enable anyone to build it.

Within every large apartment building, office or factory floor, store, warehouse, school, hotel, hospital, restaurant, beer garden, etc., etc., one of these systems may be advantageously employed. It is an absolute necessity wherever "two-way conversation communication" is desired and wherever sound is to emanate from a loudspeaker, instead of an old-fashioned drummy earpiece or headphone. Its compactness permits the convenient placement of this device on any executive's desk.

Many business institutions, such as those enumerated above, cannot afford to purchase and maintain a separate inter-office telephone board requiring a trained operator for an intercommunication service. The installation of one of these systems solves the problem economically: first, any novice can completely install it in less than five minutes, without having to take precautions of any kind; second, the use of this system saves a lot of valuable time, it being more expedient than the ordinary telephone system, as your conversation may be carried on directly without the usual delays caused by a telephone operator intermediary; third, but not least, it is so flexible in its applications that an almost unlimited number of uses may be found for it.

### Description of System

The system referred to in this article has been developed in answer to repeated demands from busy executives for whom the ordinary inter-office telephone system was much too slow and time-robbing, besides being expensive in up-

\*Chief Engineer, Coast-to-Coast Radio Corp.



keep. This two-way system consists essentially of two individual, but identical, *completely self-contained* amplifiers that are provided with individual speakers and microphones, as illustrated in Fig. A. The first amplifier, No. 1, supplies the necessary microphone current to its microphone, M1, which is mounted into the same cabinet as the first amplifier, A1. This amplifier, A1, feeds into the loudspeaker, Sp.1, which is mounted in the small cabinet (illustrated in Fig. B) housing the second amplifier A2. The amplifier A2, in turn, supplies the necessary microphone current to its own microphone M2, and its output is fed into the corresponding loudspeaker Sp.2 mounted into the cabinet that houses the first amplifier. The connections from one amplifier to the other may be made with ordinary dual conductor lamp-cord, or bell or hook-up wire (see the schematic, Fig. 1A). At the same time the two units may be placed as far as 5,000 feet apart without introducing any appreciable losses or distortion, and without the required aid of line transformers or booster units.

Because of the fact that the amplifiers employ quick-heating tubes (1 type 30, 1 type 47, and 1 type 82), they are ready for use the precise moment their switch or switches are thrown on. Should Mr. Jones want Mr. Brown to perform a certain duty for him, all he is required to do is to throw a switch and start talking. The sensitive microphone would carry his message immediately to Mr. Brown's speaker with sufficient volume to be audible in one or several average size rooms. Much time would be lost if an ordinary inter-office telephone system were employed instead, because the telephone operator may only communicate with Mr. Brown after being told to do so by Mr. Jones; the operator must then wait until somebody near Mr. Brown's telephone answers if he is not at his desk at the moment. Only after all these costly delays can Mr. Jones talk to Mr. Brown.

As an instance of its many varied uses, it might be well to cite that in a RADIO-CRAFT editorial the editor stated that if the Lindberghs had one of these units stationed in their son's bedroom, the famous kidnaping would in all probability have been foiled, since all sounds in that bedroom would have been heard by the parents in another part of the house. The system is so sensitive that any extraneous noise, however slight, would be immediately transmitted to the microphone and thence to the loudspeaker. Another field of application is whenever it is desired to be in one location and at the same time hear what is going on in another location without actually being there. For instance, a store keeper can go to the rear of his shop and hear anybody enter. Both the microphone and the speaker are separately removable and thus these units may be used as a complete conventional public address system, in the usual manner.

The power consumption of each amplifier is so low—about 25 watts—that it may be left on continuously without appreciably increasing the lighting bill. The undistorted output of each amplifier is 3 watts and, therefore, at least three speakers may be employed simultaneously in three different rooms, each providing comfortable volume.

However, by employing a switching arrangement such as that shown in Fig. 1B, any number of speakers may be individually connected to either amplifier, an application of great value to any hotel, camp, school, hospital, etc. If it is desired to employ more than two complete units, such as one central unit located on the chief executive's desk, and to permit inter-communication between that point and say three other stations, refer to the diagram, Fig. 1C, showing the switching arrangement required. Inter-communication can be carried on between any two or more stations in the system, or simultaneously among them all!

#### Theory and Circuit Constants

A close-up of the top view of one of the two intercommunication units is shown in Fig. C, and its bottom view in Fig. D. A complete schematic diagram is given in Fig. 2. During the quest for an amplifier that could be made to operate instantaneously and still possess the high amplification necessary for microphone work, it was found necessary to use a D.C. operated tube in the first audio stage: the type 30 tube was chosen. The filament current is ob-

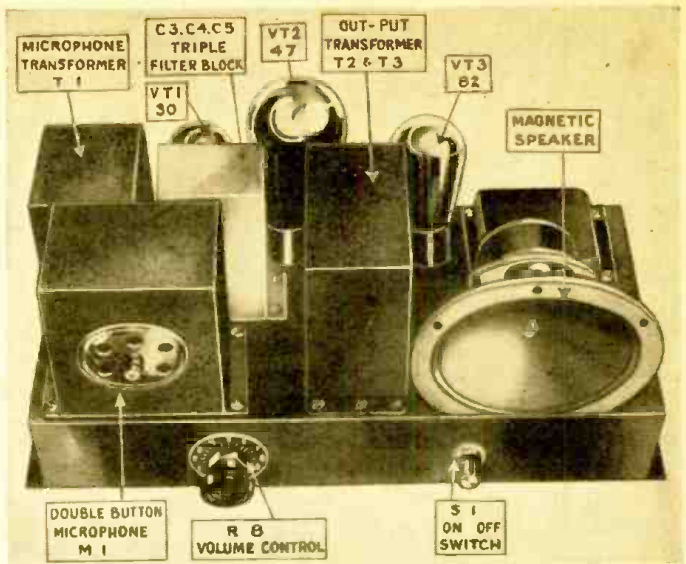

Fig. C  
Top view of the amplifier showing the location of all parts.

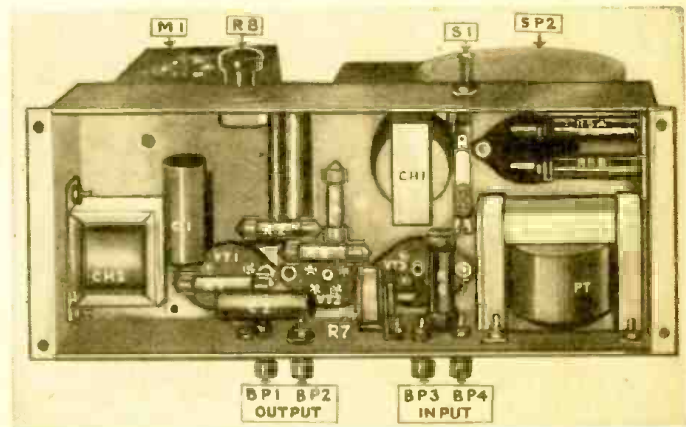

Fig. D  
Under-view of the chassis of the Coast-To-Coast communication system.

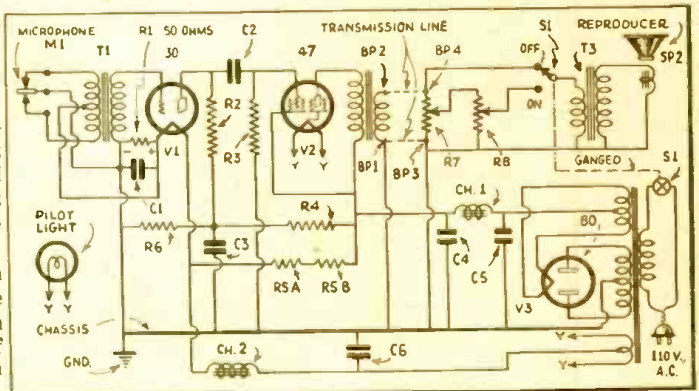

Fig. 2  
Schematic circuit of one station of the system. Two are required.

tained partly from the D.C. plate and screen currents of the 47 output tube, V2, which currents total 37 ma. These currents flow through the center tap of the filament winding of V2, through a filter choke CH2, through the filament circuit of V1, and finally through the biasing circuit. The filter choke CH2 and the bypass condenser C6 keep the audio-frequency currents out of this circuit to prevent regeneration. However, as the 30 tube requires 60 ma. for the lighting of its filament, the remaining 23 milliamperes required are obtained through the use of two 5,000-ohm resistors, R5A and R5B, connected to the rectifier circuit. Another interesting feature of this amplifier  
(Continued on page 752)



# THE ANALYSIS OF RADIO RECEIVER SYMPTOMS OPERATING NOTES

MONROE M. FREEDMAN

**S**ERVICE problems, in spite of the occasional "corkers" we run into, are not usually so complicated as, at first thought they appear to be. If Service Men would merely stop and thoroughly "look over" the set they would find that, in most cases, the difficulty could be located easily.

## Stromberg Carlson 25, 26

We have run into many complaints of starting and stopping which have been traced to their source by visual inspection.

(A) Many of these troubles have been found due to loose wires in the variable condenser compartment, which are usually in place, but unsoldered. This has been such a common occurrence that it is one of the first steps taken in locating this type of trouble. The remedy, of course, is simply soldering.

(B) It has been found that stopping and starting is also due to the 100,000-ohm fixed resistor which is in series with the center lug of the volume control shorting to the chassis intermittently. This resistor is black with a blue end, and is supported by a brown bakelite casing. A small hexagon nut holds this assembly together; on loosening, the resistor which is located just below the volume control starts its mischievous work. (Fig. 1A.)

(C) Again, starting and stopping has been found to be caused by the coil shields cutting the leads going to the coils.

(D) Another frequent cause of this trouble has been traced to the lug on the oscillator coil which receives the two wires from the center of the secondary coil. These wires have quite often been found unsoldered. (Fig. 1B.)

Cases have been found where the volume increases gradually to a point where the volume cannot be controlled at all. This trouble has been traced to:

(A) Gassy 24 tubes.

Some Service Men, in checking a 24 tube, find that the tube draws 10 milliamperes of plate current; they merely pass it on as being a perfect tube, and attribute the high plate current to a high voltage. They do not stop to consider the fact that the tube has an appreciable amount of gas in it causing this high plate current.

(B) This same trouble is also caused by defective bi-resonator condensers, which have been previously discussed. Any leak in the volume control circuit to the chassis will cause the same trouble.

(C) It has been found, on numerous occasions, that due to a 24 tube in the demodulator stage having a short from cathode to heater, the control of volume is poor, although the set works.

Many cases of microphonic howls have been received. It has been found that Service Men had previously removed practically all the bolts holding the chassis to the cabinet. But this did not cure the trouble. It was found that by taking four rubber washers (those located beneath

the Philco chassis which Service Men never replace) and placing them between the four corners of the speaker and the cabinet the howl was eliminated at once. This kink has been tried in every case where the set was found in a microphonic condition, and has never failed to eliminate the howl.

On numerous occasions it was found that these set models were very weak, and that quite a hiss could be heard in the background of the station. This condition was traced to either an open coil in the pre-selector stage or to the lack of an antenna. (Fig. 1C.)

We recently came across a case which baffled a few men. The set was very weak and distorted. A low plate voltage was found on the demodulator tube, and one 45 output push-pull tube was operating hot while the other was cold, though both plate voltages appeared normal. This trouble was traced to a shorted input push-pull transformer; the short was internal, from the primary to the secondary. (Fig. 1D.)

Another common complaint on these sets is that of a peculiar noise which seems to drive owners frantic. This noise is due to a defective .0001-mf, fixed condenser located in a choke-condenser assembly in series with the plate of the demodulator tube. It is easier to replace the entire assembly rather than to dig

into the casing containing these units. This noise sounded like the sputtering of a defective tube. (Fig. 2A.)

In another recent case, a set was inoperative due to the series grid resistor of the oscillator changing in value. This resistor is located between the center tap of the secondary of the oscillator coil and the grid of the 27 tube. The value of the resistor is 500 ohms. It is located in the same can with the oscillator coil. (Fig. 1B.)

Distortion at low volume has continually been traced to a rapid-heating tube in the demodulator stage. Replacement of the 24A tube by the 24 slow-heater tube

clears up this trouble immediately.

## Stromberg Carlson 29

The outstanding troubles with this receiver will be listed in order.

Complaints of fading have been traced, in many cases, to faulty volume controls. Because of the poor contact between the slider and the resistor, the volume control becomes "noisy." Replacement of the volume control is then essential.

"Noisy" tone controls have been found almost as often as noisy volume controls and also require replacement.

In many cases the tubes in a receiver will not light up because of a defective line switch in the tone control. In order to save the cost of a new tone control switch combination, it is advisable to interchange the tone control with the volume control. They are both of the same value, 10,000 ohms. The switch in the volume control is connected into the phonograph circuit and is hardly ever used.

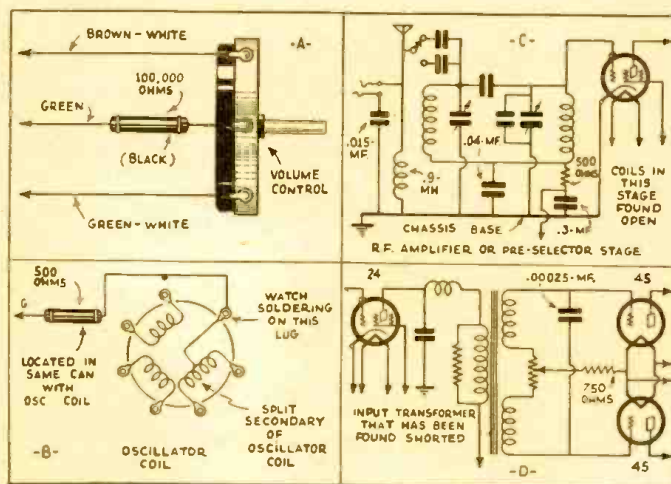

Fig. 1  
Details of Stromberg Carlson 25, 26 receivers discussed in the text.



After the change has been made, the unit previously acting as the tone control will now act as the volume control; the switch in this latter unit, which has been found defective, will not be used. The unit previously acting as the volume control will then be connected in the tone-control circuit, and its switch will be connected into the line circuit. This may involve a little more work, but will save the expense of a new unit.

At other times, we have found that all the tubes light up, and yet the set was inoperative. This condition has been traced to either a shorted trimmer condenser, usually located across the pre-selector tuning condenser, or to an open choke in series with the plate leads of the intermediate-frequency stages. This choke is located in the rear of the chassis.

Quite often complaints of hum have been encountered. The simplest remedy in this case is to merely connect an 8 microfarad condenser between the "high side" of the field of the speaker and the chassis. It has been tried in several cases, and invariably eliminated the hum.

Stromberg Carlson 38, 39, 40

In these particular models there are three outstanding service problems.

When the set is very weak with a pronounced hiss in the background of the station, the trouble may invariably be traced to either an open pre-selector coil or to the shield of the antenna lead between the binding post and the primary of the pre-selector coil being shorted to the primary of the coil.

On many complaints where reception was found very weak and distorted, the trouble has been traced to a defective 600-ohm cathode resistor in the first radio-frequency stage (58 tube). This resistor changes in value. It has been found that by shorting this resistor entirely the volume and ease of operation of the set was increased greatly. (Fig. 2B.)

Resonant hums, fading, and steady hums can usually be traced to cathode-to-heater shorts in type 56 tubes. We have found that the 56 tube has given us trouble continually, and whenever a hum is found, the type 56 tubes should be checked very carefully.

Stromberg Carlson 19, 20

One consistent complaint on this particular model is recorded. This complaint was fading, and was due to a .001-mf. fixed condenser in the grid return of the demodulator stage. This condenser is shunted with a 10 megohm resistor; it also has a tendency to open, causing fading and slight distortion. Replacing this condenser in every case has eliminated the fading. (Fig. 2C.)

Stromberg Carlson 846

These sets are now in the field approximately two years. Practically every set of this model either motorboats or oscillates. The usual trouble in this case is due to dirty rotor condenser contacts. Once cleaned, by simply running a nail file several times over the contact surfaces, the set performs perfectly again.

Brunswick 17 Series

The most common complaint received from owners of

these sets is that the set has become inoperative. The tubes light up and yet it does not work. This trouble has been traced to several causes: (a) A short circuit to the speaker frame of the high voltage; (b) the grounding of a screen-grid resistor of 14,000 ohms located in the right half of the chassis between two coil shields. Usually after the set has been operating in the home for several months the heat forces the resistor toward one side until it shorts against one of these shields.

It is always found that it is necessary to change two 5,000-ohm resistors in the oscillator stage, because these resistors also change in value.

This model set has been found inoperative numerous times because of a shorted .5-mf. condenser in the plate circuit of the oscillator stage.

Service calls have been exceedingly numerous where the customer complains of intermittent reception. Many times, by merely walking across the floor, the set would become inoperative. Many Service Men spent hours looking for loose connections which did not exist. This condition has been traced to a defective turret condition. Burrs would be found between variable condenser plates. These were eliminated simply by "flashing" the variable condenser (a high voltage connected across the unit). This would actually "burn" these burrs away.

On several occasions these sets were found to operate very weakly. This condition was traced to either open R. F. and I. F. control-grid return circuits or open bypass condensers in various positions.

Very recently we had occasion to service one of these sets which had "stumped" several good men in the radio field. Reception was very weak and distorted. This was traced to an intermittent cathode to heater short in a 51 tube in the second detector stage. Simply replacing the tube made the set perform perfectly.

A case came to our attention not very long ago where the complaint was that when the set was turned on, the intensity of the signal rose to a high level within several seconds, then it would fade away to a mere whisper and within a few more seconds the set operated normally. This always happened while the set was heating up. This condition was traced to a slow

heater in the automatic volume control stage and fast heaters throughout the rest of the set. A fast heater in the automatic volume control stage eliminated this condition.

RCA 21 Series

The outstanding fault found with this set has been with the volume control. They become "noisy" after a short while. Most Service Men simply replace this unit and call the job finished. I simply wish to make it known that these volume controls can be repaired satisfactorily. Of course, it means more time, but saves the price of a new unit.

The bakelite back must be removed by lifting three small lugs holding it to the casing. When this is removed, you will find a spring in the center of the unit which has a coat of grease and grime. By merely wiping this off

(Continued on page 754)

**WHAT THIS DEPARTMENT  
IS FOR**

It is conducted especially for the professional Service Man. In it will be found the most unusual troubles encountered in radio service work, written, in a practical manner, by Service Men for you.

Have you, as a professional man, encountered any unusual or interesting Service Kink that may help your fellow workers? If so, let us have them. They will be paid for, upon publication, at regular space rates.

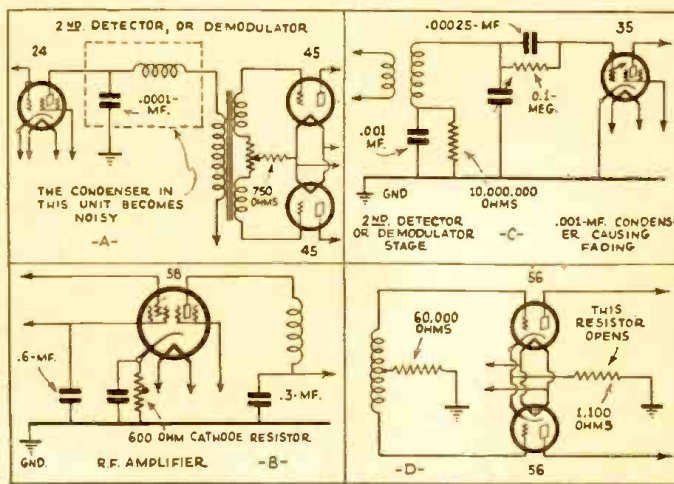

Fig. 2  
At A, detail of Stromberg Carlson 25, 26 receiver; at B, detail of Stromberg Carlson models 38, 39, and 40 receivers; detail of Stromberg Carlson models 19 and 20 at C; detail of the RCA 78 at D.



RCA VICTOR MODEL RO-23 11-TUBE ALL-WAVE SUPERHETERODYNE

(A broadcast superheterodyne—with A.V.C., tone control, and band selection—and a short-wave converter; range, 13.8 to 550 meters.)

Two chassis complete this receiver. One is the broadcast receiver, service data on which is covered by the RCA Victor Service Notes issued in connection with the models R-8, R-10 and R-12 sets; the short-wave converter, however, is described in the Service Notes in connection with RCA Victor Universal Radiola RO-23. The model RO-23 set is rated at 105-125 V., and 200-250 V., 50-60 cycles and 25-40 cycles; power consumption 120 W.; undistorted power output, 2.25 W. (Power consumption, broadcast set only, 100 W.) S.W. set tunes in 7 steps.

Tube operating voltages for the broadcast set:

Tube Type	Cath.**	C.-G.*	S.-G.*	Plate*	Plate*	S.-G.
	Volts	Volts	Volts	Volts	Ma.	Ma.
V1	4.0	0.5	70	260	4.0	0.5
V2	7.0	6.0	70	260	0.75	0.1
V3	4.0	.....	.....	65	6.0	.....
V4	4.0	4.0	70	260	4.0	0.5
V5	28.0	10.0	.....	250	1.0	.....
V6	.....	10.0	290	280	35.0	.....
V7	.....	.....	.....	25	.....	.....

(\*Measured to filament or cathode; \*\*measured to heater.) Filament potential, all tubes, 2.66 V., at 120 v., line.

In the broadcast chassis the following component values are used: Condensers C1, C2, C3, tuning condenser gang, 16 to 325 mmf.; C4, C5, C6, trimmers, 4 to 50 mmf.; C7, C12, C18, C20, 0.1-mf.; C8, C22, C26, C31, 0.5-mf.; C9, padding condenser trimmer, 15 to 75 mmf.; C10, padding condenser, 745 mmf.; C11, 745 mmf.; C13, C27, .05-mf.; C14, C15, 4 mf.; C16, C24, 15 to 75 mmf.; C17, C23, 140 to 220 mmf.; C19, 9 mf.; C21, C25, .0024-mf.; C28, .025-mf.; C29, .01-mf.; C30, 10 mf.

Resistors R1, R4, R10, R11, R21, 0.5-meg.; R2, 8,000 ohms; R3, 150 ohms; R5, 16,000 ohms; R6, 6,000 ohms; R7, R16, 40,000 ohms; R8, R15, R20, 10,000 ohms; R9, 2 megs.; R12, 30,000 ohms; R13, 1. meg.; R14, tone control, 50,000 ohms; R17, R22, 0.1-meg.; R18, 0.3-meg.; R19, manual volume control, 3,000 ohms.

The short-wave section of the receiver incorporates the following component values: Condensers C1, C3, tuning condensers, 60 mmf.; C2, C4, tuning condensers, 160 mmf.; C5, .001-mf.; C6, C10, C12, .01-mf.; C7, oscillator padding condenser, .001-mf.; C8, oscillator trimmer condenser, 51.3-98.5 meter band, 60 mmf.; C9, oscillator trimmer condenser, 38-51.3 meter band, 60 mmf.; C11, tuning condenser trimmer, 50 mmf.; C13, 100 mmf.

Resistor R1, 0.1-meg.; R2, 1,500 ohms; R3, 80,000 ohms; R4, 40,000 ohms; R5, 800 ohms.

Operating characteristics for V9, V10, V11: (\*Measured to cathode.) Line, 120 V.

Tube Type	Fil. Volts	C.-G.*	S.-G.*	Plate*	Plate*
	Volts	Volts	Volts	Volts	Ma.
V9	2.66	3	50	260	1
V10	2.66	3	50	180	1
V11	2.66	5	.....	50	5

Looking at the converter chassis with the binding posts at the rear, oscillator trimmer condenser C9 is located in front of the type 27 tube, V11; oscillator trimmer condenser C8, at the rear, almost directly in back of C9; and C7, oscillator padding condenser, at the rear and just to the right of C8.

To align the circuits of the converter so

that this unit covers each tuning band, adjust the broadcast receiver so that it is accurately set at 1,075 kc.; this becomes the I.F. for the short-wave converter. Set the "Range" switch at the 51.3-98.5 meter position. Set the tuning condenser at its maximum position (plates fully out of mesh), and place the service oscillator in operation at 5,960 kc. Adjust C8 so that the service oscillator signal will be heard in the reproducer, or noted on an output meter.

Now shift the tuning condenser of the converter to its maximum position, adjust the service oscillator to 3,055 kc., and align C7 for maximum output from the broadcast receiver (tuned to an I.F. of 1,075 kc.).

After checking each end of the 51.3-98.5 meter band, shift the range switch to the 38-51.3 meter position, and set the tuning condenser of the converter at its maximum position (plates fully out of mesh). With the same I.F., 1,075 kc., adjust C9 until maximum output is obtained from the broadcast receiver, with a service oscillator signal of 8,025 kc. When these alignments are correctly made, using an I.F. of 1,050 to 1,100 kc., the "Resonator" control will function correctly and the various short-wave broadcast services will fall within the bands indicated on the dial.

Adjust the indicator on the dial lamp to read 100 when the tuning condenser is at its maximum capacity position. *before any alignment adjustments are made.*

A defective "Range" switch may cause any of the following conditions: (a) noise, due to a corroded or loose wire or contact; (b) lack of "Resonator" control; (c) oscillator not functioning; (d) shift of dial readings.

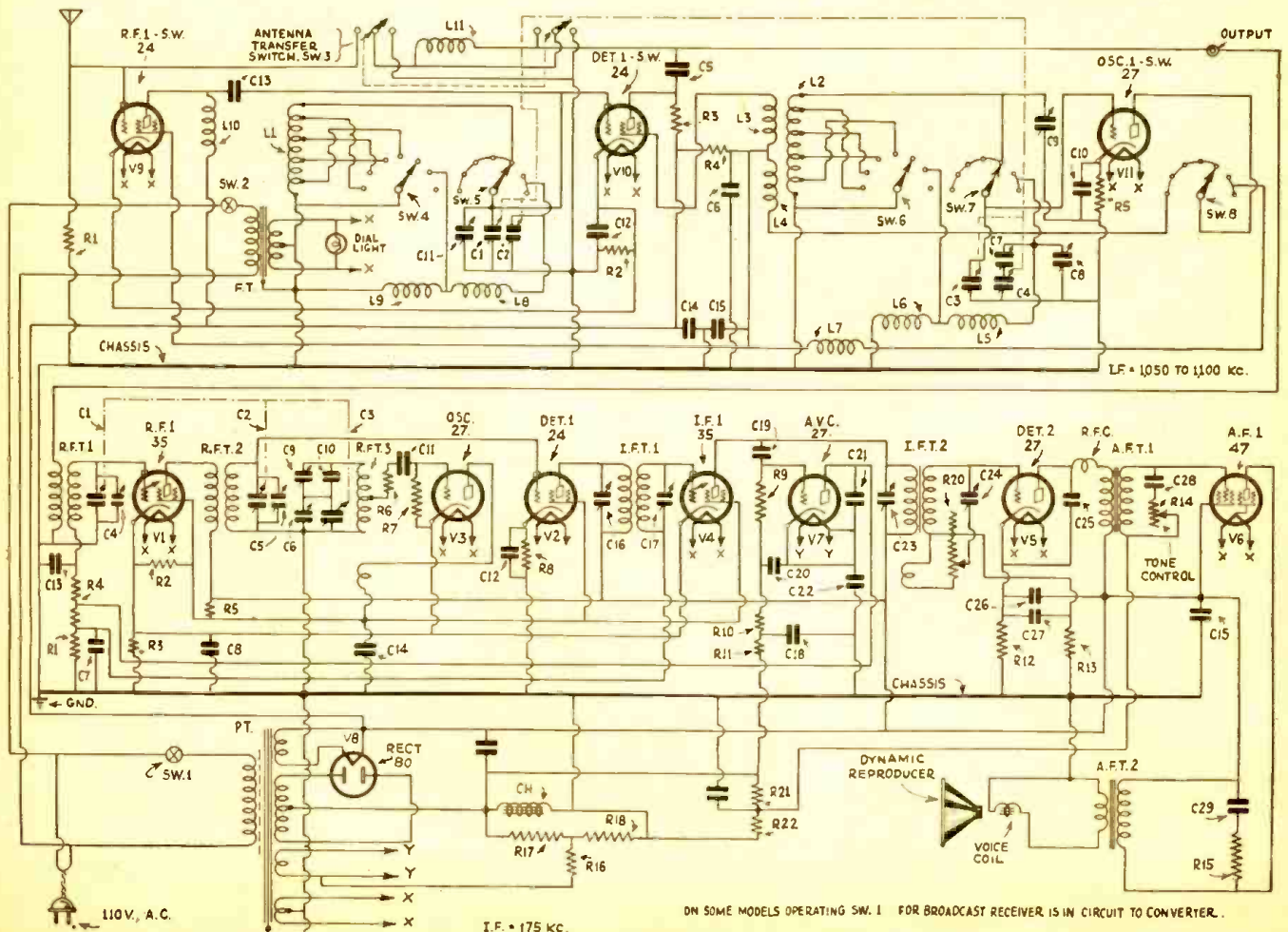



CLARION MODELS 300 DE LUXE AND 460 (2 PIECE) LEISURETTE 14-TUBE SUPERHETERODYNE

(Incorporating delayed A.V.C.; adjustable S.T.C.; dual reproducers; push-pull A.F. driver stage; push-push power output stage; visual tuning meter; automatic selectivity; tone control; twin diode second-detector.)

Exceptionally fine tone quality is probably the outstanding feature of this interesting, Transformer Corporation of America superheterodyne receiver. Operating voltages for the tubes are given in the tabulation below. These figures are obtained with the volume control, R3, full on, with the silent tuning control, R1, full open and at a line potential of 115 V.; a Weston model 565 analyzer was used.

Tube Type	Fil. Volts	Plate Volts	C.-G. Volts	Cath. Volts	S.-G. Volts	Sup.-G. Volts	Plate Ma.
V1	2.2	180	0.5	7	85	7	0.7
V2	2.2	180	1.0	7	85	7	1.2
V3	2.2	100	.....	.....	.....	.....	10.0
V4	2.1	190	0.4	4	90	4	3.0
V5	2.1	190	0.2	4	90	4	2.0
V6	2.1	.....	.....	4	.....	.....	.....
V7	2.1	.....	.....	4	.....	.....	.....
V8	2.2	180	.....	10	.....	.....	2.0
V9	2.3	185	.....	8	.....	.....	3.0
V10	2.3	185	.....	8	.....	.....	3.5
V11	2.2	400	.....	.....	.....	.....	5.0
V12	2.2	400	.....	.....	.....	.....	5.0
V13	2.0	.....	.....	4	.....	.....	.....
V14	2.3	300	.....	.....	.....	.....	.....

To further speed service on this receiver model, the manufacturers furnish the following tabulation of socket-to-ground resistance figures. Readings of 1 meg. and over are given as "Inf." Only the first three significant figures are interpreted from the ohmmeter in each reading; the value of individual resistors in the circuit can be readily checked upon removal of chassis. The readings are taken with R1 and R3 full on, and with all tubes, including the pilot light, removed.

Tube	Grid	Cath.	Heater	Plate	S.-G.	Sup.-G.
V1	Inf.	1,450	.1	6,100	3,350	1,480
V2	Inf.	5,000	.1	6,600	3,350	5,000
V3	0.1-meg.	.07	.1	3,400	.....	.....
V4	Inf.	500	.1	6,600	3,350	500
V5	Inf.	500	.1	6,100	3,350	500
V6	0.1-meg.	500	.1	500	.....	.....
V7	0.1-meg.	500	.1	500	.....	.....
V8	0.5-meg.	350	.1	8,600	.....	.....
V9	68.000	1,500	.1	6,400	.....	.....
V10	68.000	1,500	.1	6,400	.....	.....
V11	3,250	.....	3,250	6,300	.....	.....
V12	3,250	.....	3,250	6,300	.....	.....
V13	0.5-meg.	500	.1	3,400	.....	.....
V14	.....	.....	6,100	3,400	.....	.....

This set has four controls: the right-hand lower knob switches the set off and on and controls the tone; the left-hand lower knob controls the volume; the upper-center knob is the station selector, and the lower-center knob is the silent tuning control.

This receiver may be tuned in two distinct ways as suits the user; first the volume control, R3, may be turned back to the minimum position and S.T.C., R1, advanced to its maximum position. Absolute silent tuning may be accomplished by merely watching the indicating meter, M, and R3 may be advanced when the peak swing is recorded and the program brought in. The second method employed is to adjust R1 for local noise conditions by advancing R3 and tuning between stations, then retarding R1 until local interference noises are reduced to a comfortable minimum. Control R1 may then be left in this position permanently, and stations then tuned in either by audibility alone or by audibility and indicator readings. Adjust R3 to suit.

Component values are as follows: Condensers C1, C2, C3, tuning condensers; C1A, C2A, C3A, trimmers; C4 to C8, I.F. trimmers; C9, C10, C11, C12, .01-mf.; C13, C14, C19, C26, C29, 0.1-mf.; C15, 500 mmf.; C16, C25, 250 mmf.; C17, .05-mf.; C18, .005-mf.; C20, padding condenser; C21, 50 C22, 1. mf.; C23, .35-mf.; C24, 2.-mf.; C27, 8 mf.; C28, 6mf.

Resistor R1, manual silent tuning control S.T.C., 10,000 ohms; R2, tone control, 0.1-meg.; R3, manual volume control, 0.5-meg.; R4, R14, 1,500 ohms; R5, R6, R7, R8, R9, R10, R17, 0.1-meg.; R15, 10,000 ohms; R16, 5,000

ohms; R18, 500 ohms; R19, 350 ohms; R20, 3,060 ohms; R21, 2,700 ohms; R22, 1 meg.; R23, 0.5-meg.

Fading may be due to a defect in the delayed A.V.C. circuit or a defective tube as V13.

Since the tuning meter, M, indicates plate current for V2 and V4, lack of sensitivity in the circuits of V1, V2 or V4 will cause the meter pointer to have a restricted swing; whereas, if lack of sensitivity has developed in a circuit subsequent to those mentioned, the needle will swing freely, although the output of the set is weak.

To adjust the I.F. circuits, connect the service oscillator to the control-grid of V2 and adjust C4, C5, C6, C7 and C8 in this order, for maximum output at 175 kc. Next, connect the service oscillator to the antenna and ground posts and adjust C2A and C1A for maximum output at 1,400 kc.

To check the calibration of the receiver, adjust C3A until a station of known high frequency, about 1,400 kc., is brought in at the correct dial marking with peak volume.

Now, to balance the oscillator circuit to the R.F. and first-detector circuits, the procedure is as follows. With the service oscillator and the set tuned to 600 kc. slowly increase or decrease the value of padding condenser C20, while oscillating the tuning condenser gang back and forth. Readjust C20 until the needle of the output service meter reaches its peak.

Finally, retune the receiver and the broadcast service oscillator to 1,400 kc., and recheck trimmer C3A to make sure that the adjustment of C20 has not thrown the receiver out of calibration. If it has, then readjust C3A until the calibration is correct, as previously explained, and check trimmers C1A and C2A to make sure that the adjustment of condenser C20 has not reduced the sensitivity.

The effect of C26, R.F.C. and R11 is to bypass the major portion of the second-harmonic frequencies generated by diodes V6, V7. It is important that a good ground be used with this set. The power consumption of this set is 129 watts. The Clarion model 460 Leisureette receiver is distinguished from the Clarion model 300, 14-tube DeLux, by the reproducers which in the Leisureette are contained in a remote, Queen Anne-period occasional table; the receiver chassis is housed in a special, Queen Anne-period end table, with all controls on a horizontal panel. Thus, the control cabinet may be placed to satisfy individual convenience and the reproducer cabinet may be positioned to meet individual acoustic demands.

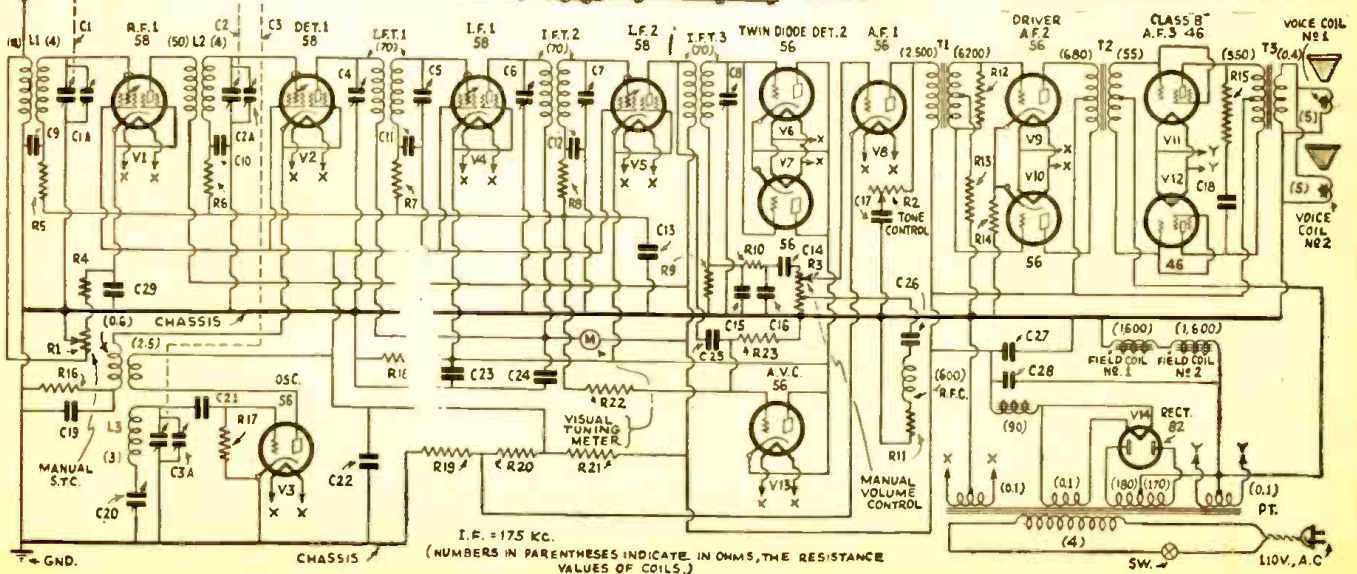
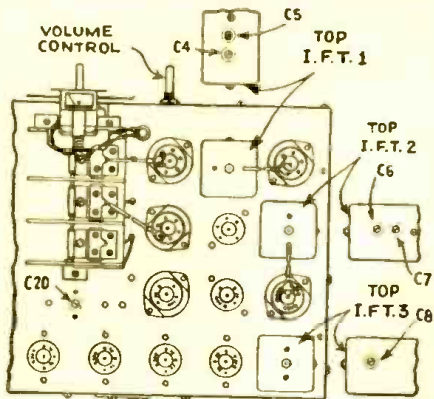



# HOW TO MAKE THE BEGINNERS' POWER CRYSTAL SET

Believe it or not, but we have received more inquiries from beginners for crystal receivers than for any other type of set. In nearly every case, after the set was constructed, the readers have written in asking how an amplifier may be attached for greater volume. In this interesting article, the author kills two birds with one stone and describes a simple, crystal-tube receiver.

F. R. HARRIS

IS IT possible to "work a loudspeaker" with a crystal set; can a set capable of good power output be built at little cost—for experimental purposes? The answer is "yes—and how"; details of the "how" part of the answer will follow. Incidentally, we will provide for picking up police calls and for phonograph.

The average beginner in radio starts off with a crystal set, and wisely so, since he has then but two variables to deal with: the signal or radio frequency; and the sound or audio frequency. All considerations of filament voltage, plate voltages, screen-grid voltages, and the multitude of other complicating factors present in tube sets are absent. However, there is one serious defect of standard crystal sets—their lack of power. They are strictly limited to headphone use, and while that may satisfy the beginner

for a while, he soon grows tired of his isolation and wants to build a set that he can "show off" to his family and friends. Of course, there have been rumors, and rumors of rumors, concerning loudspeaker crystal sets; but, in the writer's experience, these sets are a great deal like ghosts. One often meets a person who knows some one who has seen a ghost, but never a person who will say that he, personally, saw one. So we have in favor of the crystal set its simplicity and perfect tone quality; and against it, its extremely low power capabilities which make it a strictly headphone device. Are we, therefore, to say that if we wish power, we must give up the crystal with its superb tone and go in for tube sets altogether? No, there is another possibility. We can combine these two types of receivers, using tubes to build up the signal, or amplify (since that is the thing they do best) and leave the job of detection, or changing the radio frequency to audio frequency so that our ears may hear it, to the crystal. Therefore, we will set about to design a set along these lines.

## Theory

Any radio set, from the simplest to the most complicated consists of six basic parts: a collector, or aerial, of some

sort to pick up the radio energy emitted from the broadcast stations in operation at the time; a selector, or tuning system, to select the particular station wanted and reject all others; a radio frequency amplifier, to build up the minute energy picked up by the collector to the level necessary to reproduce at the receiver exactly what occurred in the studio at the transmitter; a detector, or demodulator, which serves to select the audio frequency variations from the radio-frequency carrier wave; an audio-frequency amplifier to build up the audio frequency output of the detector; and a transducer, or device to transform the electrical energy into sound energy which may be heard by our ears—the loudspeaker or headphones. The collector is always the first of the chain and the transducer the last.

Now, the vacuum tube is such a marvelous and versatile

device that it can be made to amplify anything from direct-current signals to signals that vary, or oscillate, at a rate of twenty million times a second, and in a properly designed amplifier the current variations that appear in the plate circuit of the last tube are exact duplications, within a very small percentage, of the voltage variations that are applied to the grid of the first. However, there are other factors besides the selection of tubes to be considered in the design of our

"power crystal set" and these, too, will be discussed in due course.

## Design

Now, let us see just what data we have so far accumulated on which to base our design. Since it is to be a beginner's set it must be simple; and since the late, lamented depression is not yet altogether a memory, it, also, must be low in cost. It must incorporate a crystal detector for simplicity and tone quality, and it must incorporate vacuum tube amplification so that we can use a loudspeaker and "show it off" to admiring (?) friends and the family.

Right here we must choose between amplifying the signal at radio frequency, at audio frequency, or both. Radio-

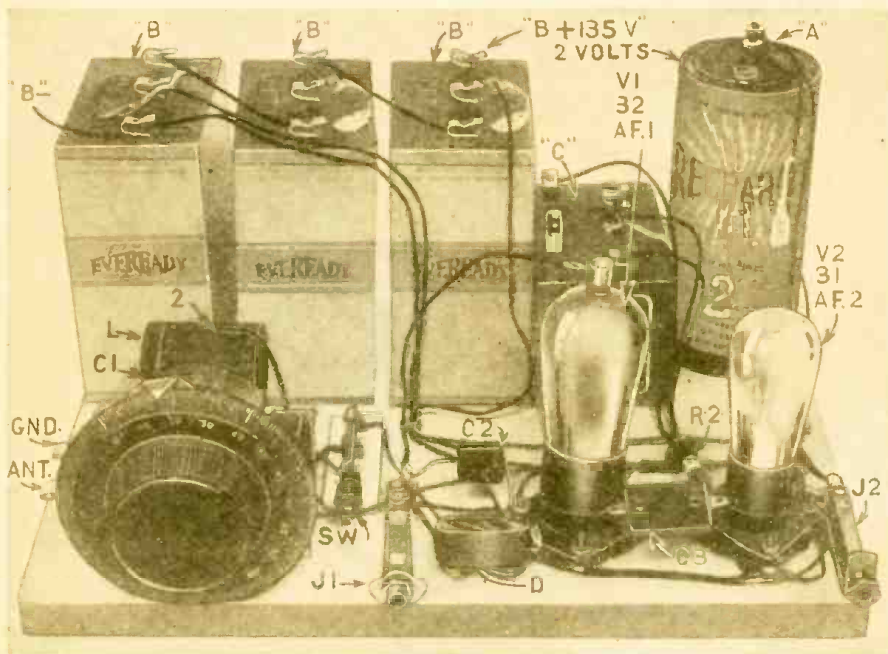

Fig. A

An excellent photograph showing the location of all parts of the simple beginners' power crystal receiver. Refer to the List of Parts and the schematic circuit of Fig. 1 for values.



## THE RADIO BEGINNER

• In this department we shall print every month simple, but effective radio sets and circuits, and other information for radio beginners, or those just starting in radio. There are thousands of radio fans and experimenters who are still interested in building their own, and in experimenting with home-made sets. The new instruments, as well as the new tubes, make this endeavor of particular importance.

If you build the sets described in these pages, won't you be good enough to advise us what results you are getting?

frequency amplification has several advantages; it is efficient and can be made to have a much higher gain per stage than audio amplification. If properly designed, it does not distort the audio modulation carried by the signal as audio amplifiers nearly always do; hence, we can use more stages (up to four or five, in a well shielded and filtered design), and build up the signal to a high level without paying for it in poor tone quality. But, for our purpose, it also has several major disadvantages. *The power handling capabilities of a crystal are strictly limited*; and, if too great a signal voltage is applied, there will be minute arcs at the catwhisker's contact point and the crystal will be destroyed. Also for loudspeaker operation it is necessary to use audio amplification in addition to whatever radio amplification is used. Furthermore, each stage of radio-frequency amplification requires a tuned circuit which is difficult to line up. Taken all in all, a multi-stage R.F. amplifier is not a good job for a novice to attempt to build.

This leaves a remaining choice of A.F. amplification which has all of the necessary gain to achieve loudspeaker operation from a crystal output on local stations and is considerably easier to handle than R.F.

We still have a choice of either transformer or resistance coupling between the audio stages; but, in view of the fact that resistance is considerably cheaper and with the use of a screen-grid tube is practically as efficient as transformer coupling, we have selected resistance coupling for our receiver.

The output tube, a triode, has been selected in place of the more generally-used pentode, a higher-gain tube, because of the more reliable results which may be obtained by the inexperienced experimenter. (A later design may incorporate a pentode.—*Editor.*)

A reference to the picture illustration of the parts arrangement, Fig. A, very clearly shows the position of each component. The space at the rear of the "breadboard" is just sufficient for the battery power supply. The set is so simple that very little need be said along the line of instructions for the assembly beyond the general advice to keep all leads carrying high frequency, the grid leads in particular, as short and as direct as possible; although, in a simple, low-gain set of this type, trouble from feed-back is hardly likely to be encountered. Jack J1 in the grid circuit of the type 32 tube allows the use of a phonograph pickup and is very useful in testing at the time of assem-

bly; since, if satisfactory results are attained when a phonograph pickup is plugged in, whatever other trouble may be encountered is at once automatically localized in the R.F. or detector section.

Be sure that all soldered joints are really *soldered*, and are not simply the "rosin" joint that results from the use of a cold iron or a poorly-cleaned surface.

The only trouble that the novice is likely to encounter is tapping coil L for police-band reception; but, if care is used in pushing the wire out from the inside and scraping it clean before soldering the lead to the knife switch, it can be done successfully. This tap is made 35 turns back from the grid end of the coil; this is the end opposite to the antenna coil. Thus, close coupling between primary and secondary is maintained.

### Operating Hints

When the set is all wired and ready for operation connect the "A" battery and place the tubes in their sockets; if the tubes light, the chances are that the filament circuit is correctly wired. Then plug in the headphones or speaker and connect the "C" battery in place; then the "B" batteries.

If everything is O.K. there will be a loud click when the 135-volt wire is touched to the "B" battery, and a loud hum or buzz when the grid cap of the type 32 tube is touched with the finger. Then, if you have one, plug in the phonograph pickup and start the record. If you have done your work correctly, you will be rewarded with music. If you have no phono. pickup, you will just have to trust to luck that the audio is O.K.

Next attach the aerial and ground wires, see that the wave-change

switch, Sw., is in the broadcast position, 1 (all the coil in use), and start to "fish." And here your patience will probably be tested. On the detector you will find a little lever. A very light pressure of this lever will be found best; if the wire is not making contact, this fact will be indicated by a loud buzz from the phones, which, by the way, you had better use for the first adjustment. From this point on it is just a question of juggling the tuning condenser and the detector adjustment until a signal is heard, then you can work for best response.

The three 1. mf. bypass condensers, C5, C6, C7, and one 4 mf. unit, C4, shown in Fig. 1, are not absolutely necessary, but operation of the set, especially with old batteries which are not quite "up to snuff," but which work, will be some-

(Continued on page 749)

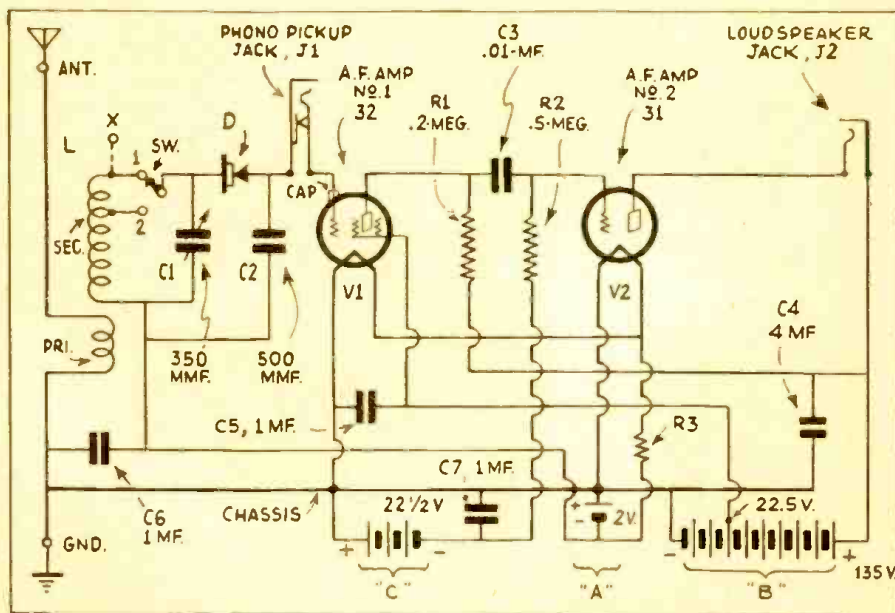

Fig. 1  
Schematic circuit of the receiver completely described by the author in this real beginners' article.







# MODERN COMMERCIAL AUTO-RADIO RECEIVERS

A survey of the files of the leading radio set manufacturers would show, no doubt, that nearly every one of them have, or will have soon, a 1933 auto-radio receiver. Manufacturers who have never produced auto sets are now making them. Manufacturers who previously saw no profits in this outlet, have changed their minds and are now entering this field to the blare of trumpets and heavy advertising.

The material presented in the following pages is the result of many months of painstaking work by RADIO-CRAFT. It does not represent all the auto-radio receivers now on the market; it does represent, though, the most complete technical discussion of modern auto-

radio receivers that has appeared in any magazine in any one issue at any time. Each description is accompanied by the circuit diagram with all values marked; photographs appear in every case where they were available; and many sketches of installation or servicing assistance appear.

The receivers described are modern—obsolete receivers either are not described or have been published in past issues of this magazine. If a modern auto receiver is not described here, it is because the manufacturer failed to supply us with the necessary technical information. Mr. Service Man, make the most of this information.

● The following information was compiled by RADIO-CRAFT in response to special requests. This information should be of invaluable assistance to Service Men contemplating the installation of automotive receivers and will be enlarged upon from time to time as additional data are secured.

**AUBURN**—Closed types on models 8-105 and 12-165 are wired for radio. In Cabriolet and Phaeton sedans, in above models, antenna is optional.

**AUSTIN**—Radio aerials in Austin cars are not standard but are optional equipment. However, they are factory-installed, under the roof covering of all models, at a slight additional charge.

**BUICK**—1933 series 50: Business, Sport, Convertible Sedan, and Victoria Coupes are equipped with aerials. 1933 series 60: Sport, Convertible, and Victoria Coupes, Convertible Phaeton, and Sedans are equipped with aerials. 1933 series 80: Sport, Convertible, and Victoria Coupes, Convertible Phaeton, and Sedans are equipped with aerial. 1933 series 90: Sedan model 7-P, Limousine, Club Sedan, Victoria Coupe, and Sedan model 5-P are equipped with aerial.

**CADILLAC**—In 1933 closed models: galvanized screen in top; closed models, tinsel tape or braid in top. Lead-in, closed cars, down front; open cars, rear.

**CHEVROLET**—All 1933 models have aerials built into the headlining. The lead-in is located in the left side front windshield post.

**CHRYSLER**—Aerials installed at factory in all closed models of 1932 and 1933 Sixes and Eights.

**CORD**\*—No antenna system in 1933 models.

**CUNNINGHAM**—Antennas installed on special order only.

**DE SOTO**\*—1933 closed models: poultry screen in roof; open models, a stranded wire is woven in false headliner on special order only. Lead-in, closed cars, down side; open cars, rear.

**DE VAUX**\*—In 1933 closed models: although there is a poultry screen in roof, an antenna will be furnished on special orders. Lead-in, down front.

**DODGE**—1933, 8 cylinder: 4-door Sedan, 5-passenger Coupe, Rumble Seat Coupe are equipped with aerial. 6 cylinder: 4-door Sedan, 2-door Sedan, Business Coupe, Rumble Seat Coupe are equipped with aerials. An opening in the floor is provided for the installation of a radio set manufactured for Dodge cars by Philco Transitone.

**DURANT**\*—No antenna system in 1933 models.

**DUESENBERG**—Aerials installed on special order only.

**ESSEX**\*\*—1933 models: stranded wire antenna in top only on special order.

**FORD**—The following 1933 cars are installed with an aerial: Tudor, Fordor, and Victoria. The following 1933 models have running board aerials: Roadster, Phaeton, Cabriolet, 3-window Coupe, and 5-window Coupe.

**FRANKLIN**—1932-1933 series 16 and 17 have insulated chicken wire in roof which may be used as an antenna. The series 18, of the same years, have grounded chicken wire.

**GRAHAM-PAIGE**—Aerials installed on special order only.

**HUDSON**—1933 Terraplane "6" and "8" and Hudson "6" and "8"; all closed cars equipped with antennas.

**HUPMOBILE**—1933 models 321, 322, and 326 are equipped with antennas; antenna lead-in under cowl.

**LA SALLE**\*—1933 closed models: galvanized screen in top; open models, tinsel tape or braid in top. Lead-in, closed cars, down front; open cars, rear.

**LINCOLN**—All closed models are equipped with antennas.

**MARMON**—Standard equipment in 1930 models 69, 79, and Big Eight; 1931, models 88. The 1932 and 1933 16-cylinder cars are not equipped with an aerial but there is a wire mesh, in the head-lining, to which a lead-in may be attached and run down the left side front windshield post.

**NASH**—1932-1933, series 1000: first batch of cars equipped with antenna, with no lead-in. Later models, lead-in down left center post; present model, lead-in down right front corner post. Sixteen spark plug suppressors and two distributor suppressors, standard equipment in twin-ignition models, series 1080, 1090, 1180 and 1190.

**OLDSMOBILE**—1933, 6 cylinder models: Business, Sport, 5-passenger, Touring Coupes, 4-door Sedan, 4-door Touring Sedan, and 5-passenger models are equipped with aerials. 1933, 8 cylinder models: Business, Sport, 5-passenger Coupes, 5-passenger Touring Coupe, 4-door Sedan, and 4-door Touring Sedan are equipped with aerials.

**PACKARD**—1933 models: All closed cars equipped with aerials.

**PEERLESS**\*—1933 closed models: poultry screen in roof. Shielded lead-in, closed cars, down front.

**PIERCE-ARROW**—1930 models A, B, and C equipped with aerials. 1931 models 41, 42, and 43 equipped with aerials. 1932 models 51, 52, 53, and 54 equipped with aerials. 1933 models 836, 1236, 1242, and 1247 equipped with aerials.

**PLYMOUTH**—Antennas are factory-installed in 1933 models.

**PONTIAC**—1933, 8 cylinder models are equipped with roof antennas with the lead-in behind the right cowl trim pad. No other models are equipped with aerials.

**REO**\*—Flying Cloud model 52: equipped with antenna, only on special order. Royale N-2 for 1933, equipped with antenna. Open and convertible Reo's will be supplied with antenna system on order.

**ROCKNE**—1932 models: Sedan and Coupe are equipped with aerials. The Convertible Sedan and Convertible Roadster are not equipped with aerials. 1933 models: Sedan and Coupe are equipped with aerials. The Convertible Sedan and Convertible Roadster are not equipped with aerials.

**ROLLS ROYCE**\*—Special bodies. Antenna can be furnished.

**STUDEBAKER**—The following Studebaker cars are equipped with aerials: 1930 starting July, models 70, 80, and 90; starting June, 1931, models 61 and 54; 1932 models, 91, 71, 62, and 55; 1933 models, 56, 73, 82 and 92. In 1933 Convertible Sedans and Roadsters aerial is installed at factory as optional equipment, at slight extra cost.

**STUTZ**—Aerials installed on special order only.

**TERRAPLANE**\*\*—1933 models: stranded wire antenna in top, only on special order.

**WILLYS KNIGHT**\*—1933 closed models: stranded wire in top; open models, none. Lead-in, closed cars, down front.

**WILLYS OVERLAND**—1933 model 99 is equipped with aerial.

(\*Courtesy, Philco Transitone. \*\*Courtesy, Zenith Radio Corp.)



**ATWATER KENT MODELS 636 AND 756**

MODELS 636 and 756 are similar six-tube superheterodynes equipped with all-electric power supply, eliminating the use of dry batteries. Model 636 is designed for attachment to and operation from the instrument panel of the car, the dynamotor power unit being in a separate metal container mounted under the floor, the front seat, or in any other convenient place. Model 756 is intended for cars on which the 636 can-

not be mounted by reason of car design. In this type a special steering post control is provided and the radio chassis (complete with power supply in a single case) may be mounted under the floor board. With both models the loudspeaker is a separate unit.

Ignition suppressors included with set.

The tubes used are: two 41's, two 39's, one 36, and one 85. Among circuit features are automatic volume control, push-pull output, two-point tone control. Tuning range 1500-540 kc. Tuning dial calibrated in kilocycles. Total battery consumption, including dynamic speaker, 5 3/4 amperes. I. F., 262 1/2 kc.

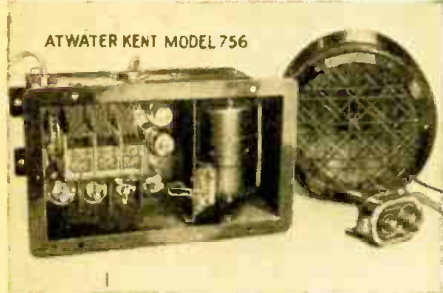
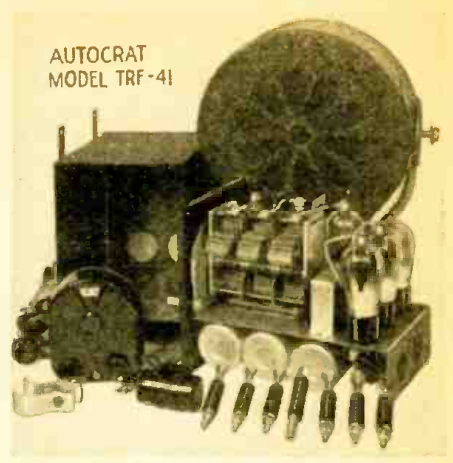

**AUTOCRAT MODEL TRF-41**

A feature of this set is the small dimensions of the chassis which measures only 5 1/4 x 6 1/2 x 8 1/4 ins. Police calls may be received on this set. Complete equipment, illustrated, at the list price includes: one shielded T.R.F. chassis with tubes, remote control unit, 30-foot cables, separate dynamic re-

producer, sub-car antenna, six spark plug suppressors, distributor suppressor, distributor filter condenser, and miscellaneous hardware. The "B" supply, which may be batteries or an eliminator, is an accessory to be bought separately.

The reproducer is of one-hole mounting type; the set, 3-hole. These two units are electrically connected by means of plugs. The receiver is designed for bulkhead mounting—as far as possible from the ignition coil. The remote-control unit clamps to the steering column. The sub-car antenna is to be slung between the front and rear axles, toward the rear. Place the "B" supply wherever convenient.

This T.R.F. receiver incorporates: two type 39 R.F. tubes; one 36, detector; one 37, first A.F.; and 41's in push-pull A<sup>1</sup>, second A.F.; sensitivity, less than 1 microvolt-per-meter; power output, 3 watts. The total "B" voltage required is 180.

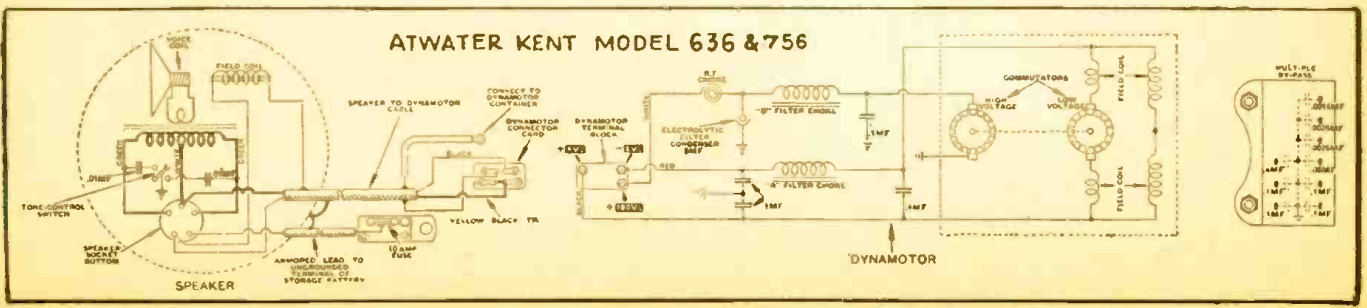
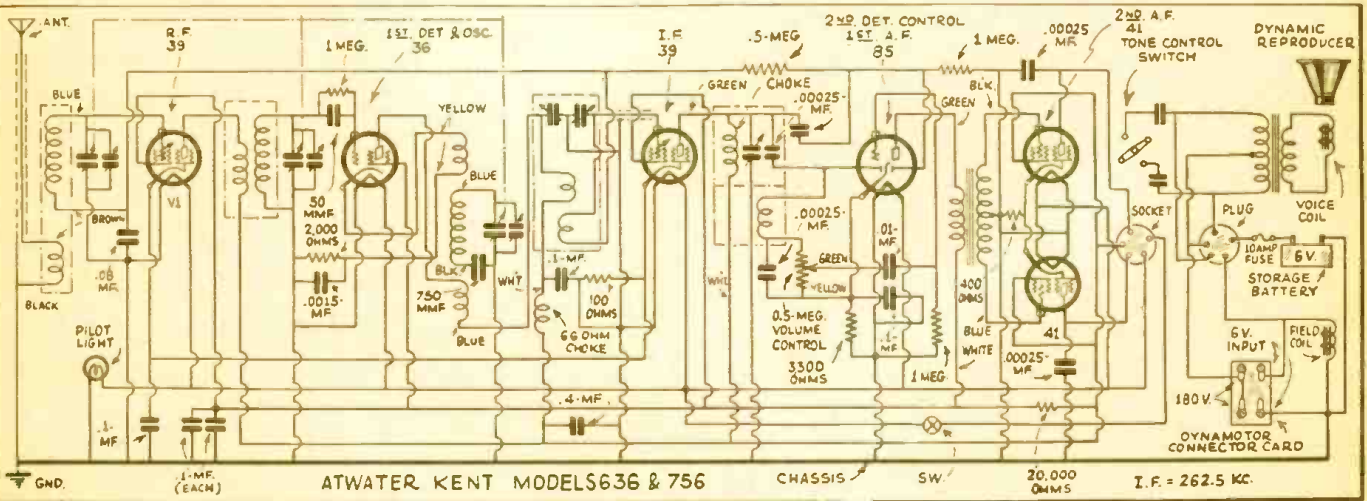
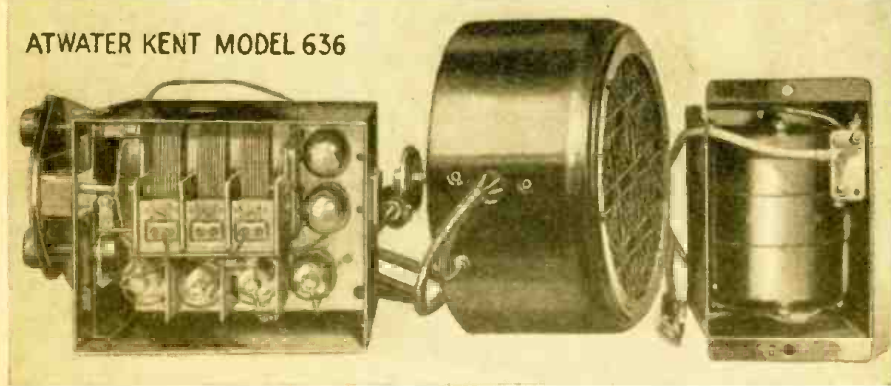



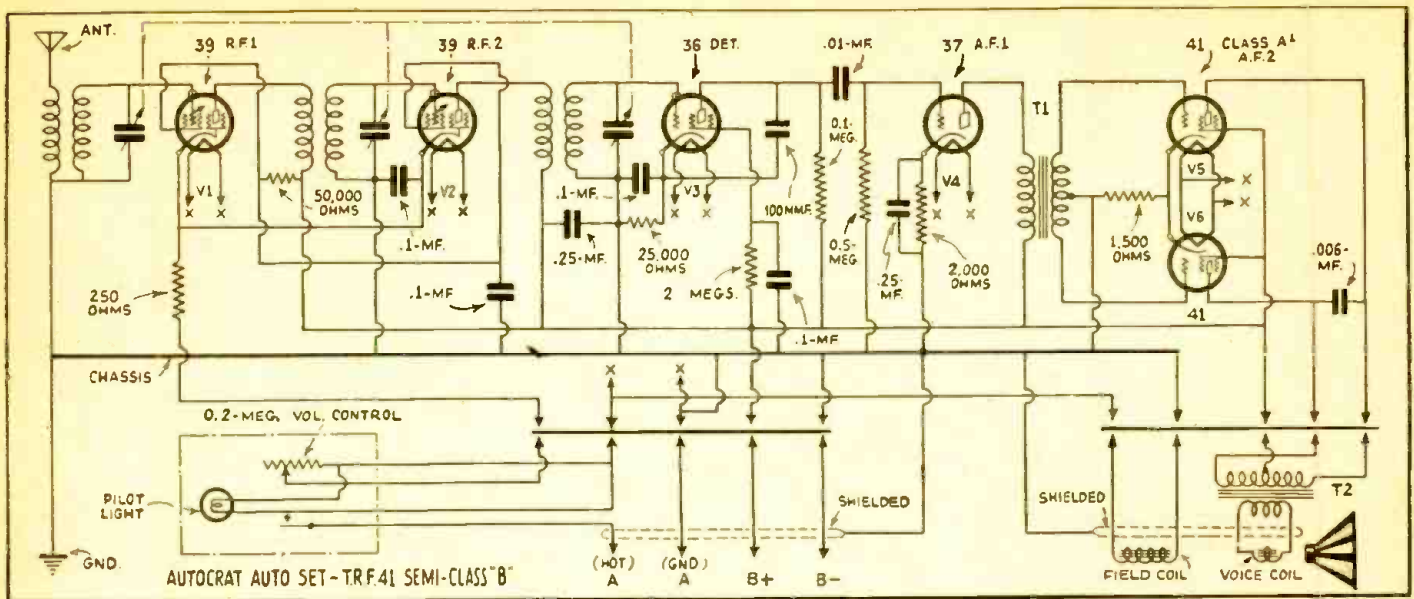

### CHEVROLET "GENERAL MOTORS"

This receiver is the United Motors Service set described in this issue.

### CROSLY ROAMIO MODEL 98

REMOTE control unit, receiver chassis, plate power unit, and loud-speaker are separate units comprising the Crosley Roamio Model 98. Control clamps to the steering column, while the other units are placed under the instrument board in the most convenient manner. The chassis measures 6 1/8 by 7 1/8 by 7 1/8 inches, the power unit 2 3/4 by 7 3/4 by 4 1/4 inches, the dynamic speaker 8 7/8 square by 5 3/4 inches deep. Ignition suppressors included.

Five tube superheterodyne circuit uses one 77, two 78's, one 75, and one

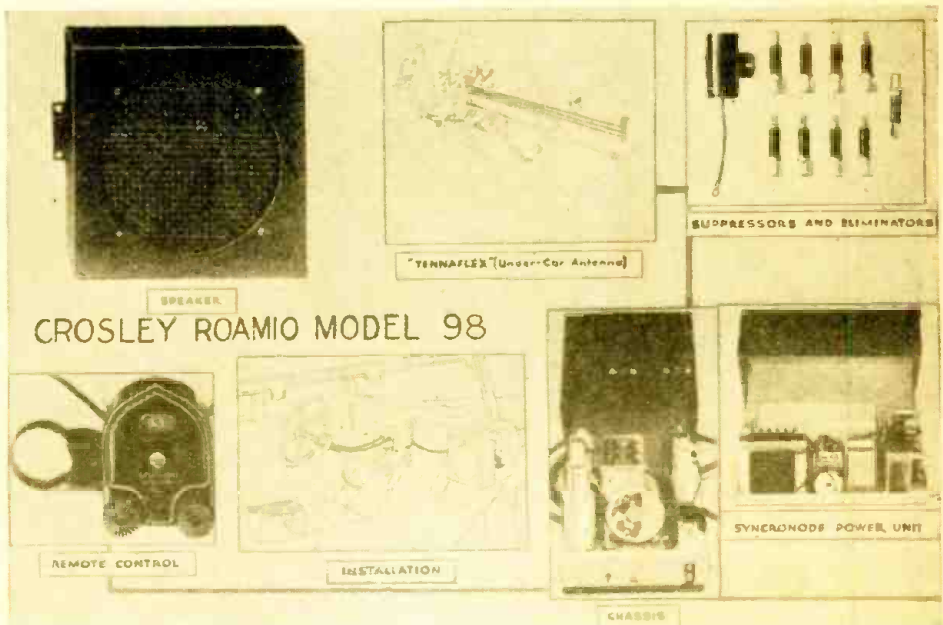

### CROSLY ROAMIO MODEL 98

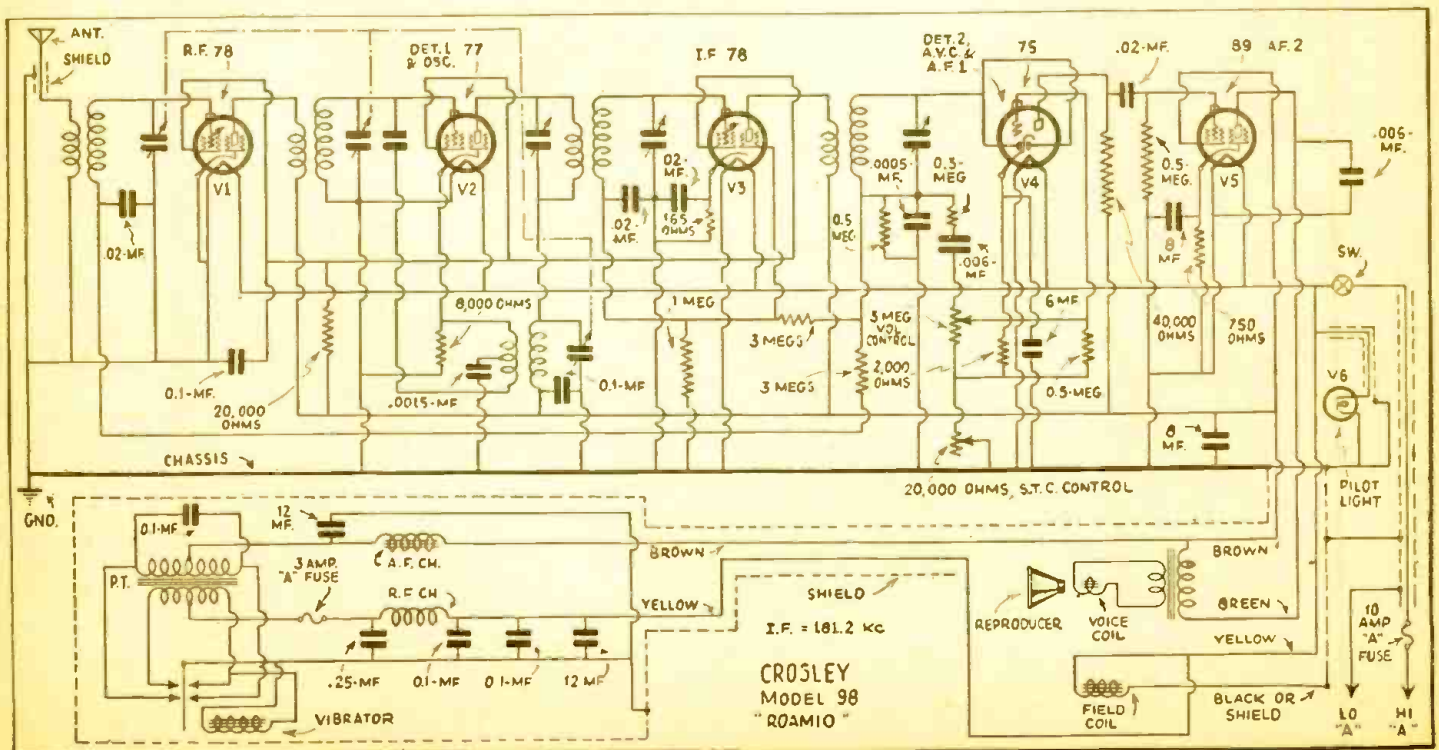



89. I.F. is 181.2 kc., current drain 4.6 amperes at 6.3 volts. Quiet automatic volume control, full floating moving coil dynamic speaker. The "B" unit is of the vibrating type, with the sparking at the contact points entirely eliminated by a new method claimed to be exclusive with Crosley. The "B" called "Synchronode." No rectifier tube used.

The following chart gives the tubes, their functions, and voltages, measured with the receiver in operating condition but with no signal to the antenna circuit. Use a high resistance D. C. voltmeter (1000 ohms per volt, or more) for all measurements. The voltage limits are + or - 10% of the values given.

All voltages are measured from tube contact to chassis with 6.3 volts at battery and 180 volts from the Synchronode.

The "I" control should be entirely off.

Tube	Position	Plate Volt.	Screen Grid Volt.	Cath. Grid Volt.	Supp. Grid Volt.	Fil. Volt.
78	R. F. Amp.	180	85	0	0	6.0
77	Osc. detector	180	85	4.5	4.5	6.0
78	I. F. Amp.	180	85	2.0	0	6.0
75	Diode—A. F. Amp.	130		1.5		6.0
89	Output (Class A Pentode)	180	180	17.0	17.0	6.0

### FADA MODEL 101 "MOTOSSET"

COMPRISES three units: a control head that clamps to the steering column, a fully enclosed receiver unit including plate supply device, and a separate dynamic loudspeaker. A flexible shaft connects the first two units. The receiver box measures 10 1/8 inches long, 7 1/8 inches high and 7 3/4 inches deep; the speaker, circular in shape, is 9 1/2 inches in diameter, 4 1/2 inches deep. Noise suppression equipment is furnished. Automatic lock closes when volume control is

turned to minimum setting; a key releases it. Antenna not included.

Backlash in the remote control has been eliminated by a worm gear drive on the condenser shaft, with constant tension maintained by a strong spring.

Eight tube superheterodyne circuit, with automatic volume control. Tubes used: three type 39, one 37, one 85, two 89, one 98. Current drain from car's storage battery, 6 1/4 amperes. I. F., 175 kc. Sensitivity 1 m.p.m.

Output 3 watts. Plate power unit is of the vibrator type with a full-wave mercury-vapor rectifier tube. Mechanical hum eliminated by sealed lead housing, 3/8 inch thick.

An automatic relay is incorporated in the chassis to prevent operation of the set on a low storage battery.

### FORD-MAJESTIC MODEL 114 AUTO-RADIO SET

"A FLOOR board installation," characterizes the Ford-Majestic 6-tube car radio receiver. The set chassis and the motor generator drop into water-tight, drawn-sheet-steel pans recessed in the floor; both containers measure 6-1/32 x 9-7/32 long, inside dimensions. The arrangement is illustrated.

A complete Ford-Majestic installation includes the receiver chassis and tubes, 180 volt motor-generator "B" supply, steering-column control head, separate 6-in. dynamic reproducer, generator and distributor filter condensers, spark plug suppressors, fuses, running-board antenna, necessary

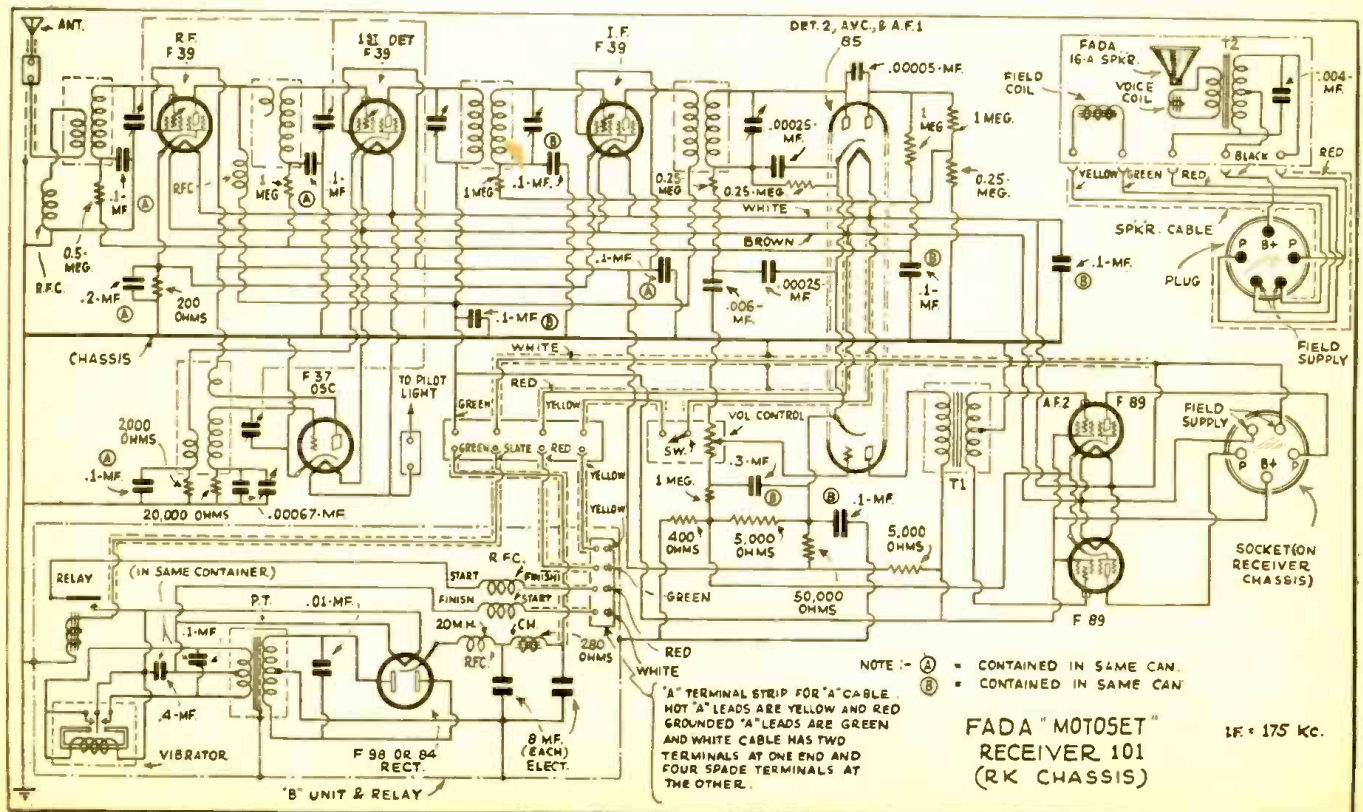
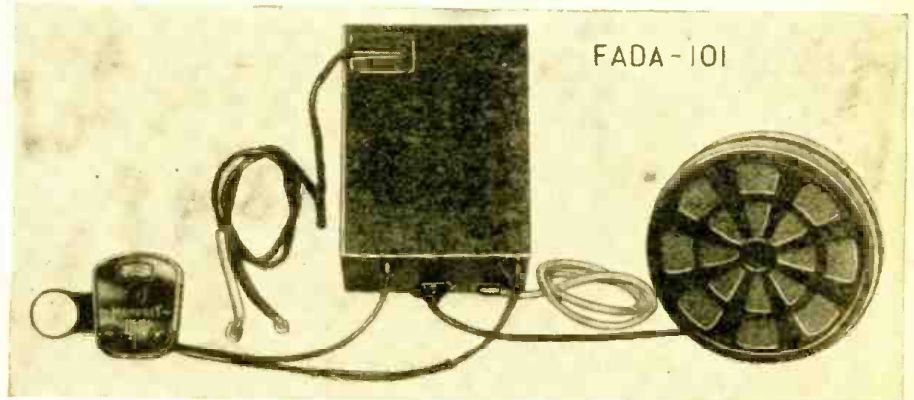
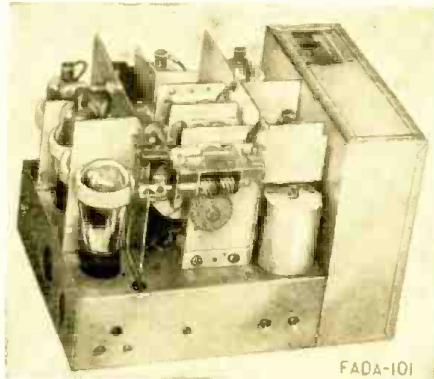







## FRANKLIN MODEL 100

THE Franklin Model 100 auto-radio receiver is a six tube set using a dynamic speaker, equipped with an under-car antenna and all accessories required to operate the set. The accessories include all spark-plug and distributor suppressors, generator condenser, antenna, loudspeaker of the dynamic type, batteries, battery box,

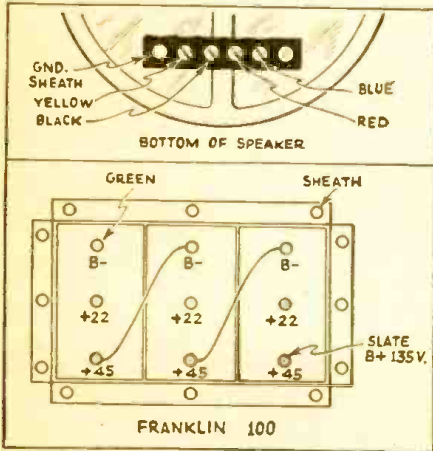

tubes, remote-control tuning unit, and brackets for same.

The receiver is designed for an under-car antenna which preferably should be placed under the car as low as possible and extending from the front to the rear axle. The receiver proper is so designed as to mount either on the steering column (as shown in the illustration) or on the dash in either the driver or engine side of the bulkhead. If possible, the set should be mounted on the right-hand side of the driver's compartment side of the dashboard when not mounted on the steering column.

The "B" battery box should be mounted on the floor boards, if possible. When mounting the battery box, be sure that the location is such as not to interfere with the normal operation of brake rods, etc.

The circuit reproduced here, is of the superheterodyne type and consists of a combination detector-oscillator tube with a band-pass input stage using a 36 tube; an I.F. amplifier using a 36 tube and tuned to 175 kc.; a second detector using a 36; a first audio

stage using a 37; and a push-pull output stage incorporating two type 38 pentodes in push pull. When first operated, the antenna stage must be resonated to the particular antenna used, by rotating a small screw located on the left hand side of the set.

The "B" source consists of three 45-volt batteries housed in a box, as previously described. The color code of the wiring to both the speaker and the batteries are illustrated here.

## FRANKLIN MODEL 200

THIS is a six-tube superheterodyne, with steering column remote control. The receiver, minus plate supply, and the loudspeaker are separate units. No plate power device is furnished, but a metal container for "B" batteries is included, as are ignition suppressors. The set may be mounted on the steering column or under the dashboard. The speaker is of the dynamic type. Tubes used are two 36's, one 37, one 85 and two 89's. Requires 135 volts of "B" from either batteries or any auto-radio power unit of proper capacity.

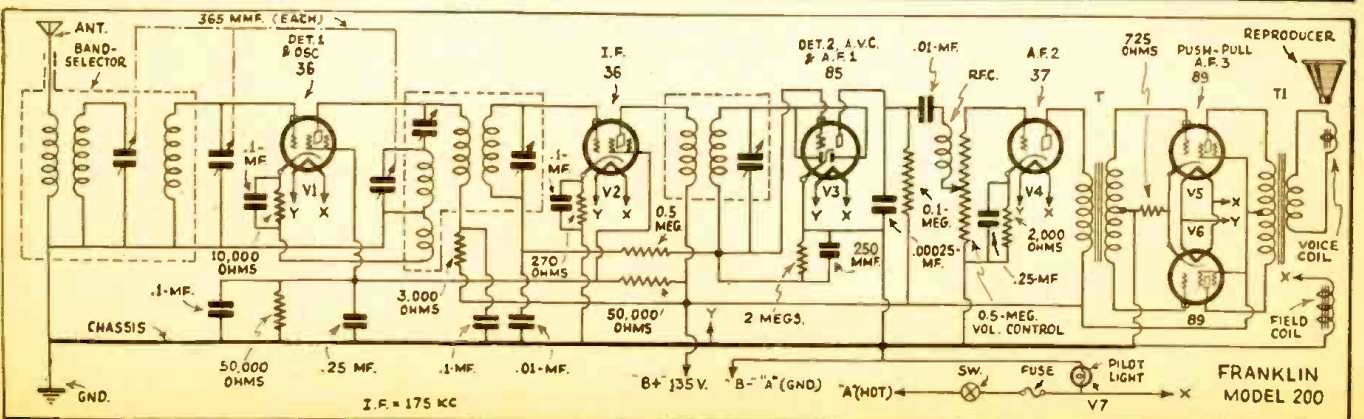
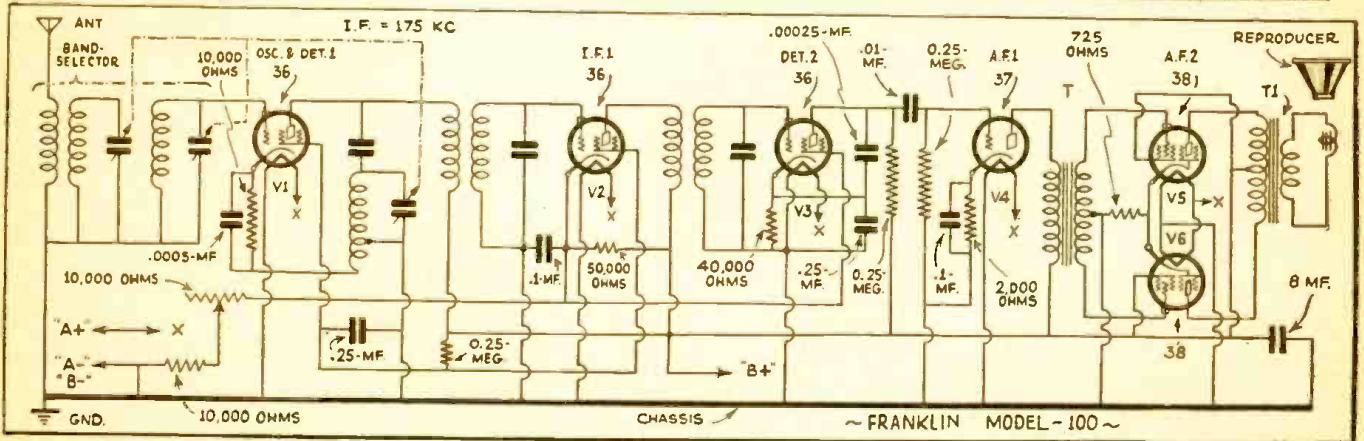
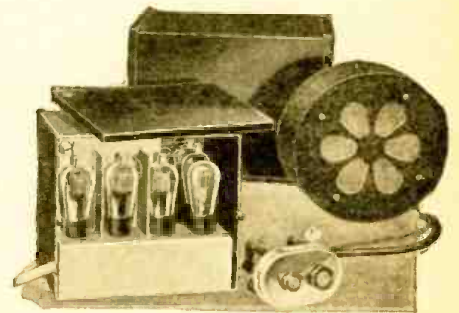
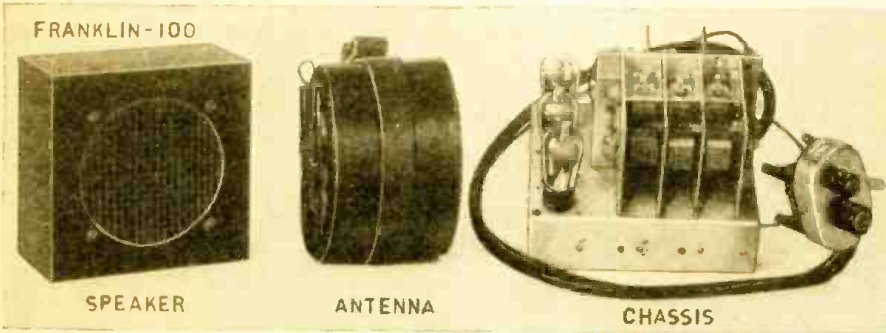



## GENERAL ELECTRIC MODEL B-40

THIS 4-tube superheterodyne follows the same design as the RCA Victor model M-34 receiver described in this issue.

## MAJESTIC MODEL 116

THE Majestic model 116 auto-radio is a six-tube receiver. It is of the single unit construction: the speaker, "B" source, and set are all in a single housing. Majestic calls this "B" unit the "Duro-Mute." This unit is of the vibrator type and receives its magnetism from the core of the power transformer, thus eliminating the necessity of separate excitation for this unit. The receiver is equipped with a remote-control tuning unit.

The set should be mounted on the fire wall (bulkhead) behind the instrument panel in either a verticle or

horizontal position. Either a roof or capacity-plate antenna may be used.

The kit of accessories includes six spark-plug suppressors, one distributor suppressor, and two .5-mf. condensers. A photograph of the receiver with all accessories is shown. A sketch of the single-unit assembly and a sketch of the chassis and control unit are also shown.

The circuit is a superheterodyne us-

ing the following tubes: G-57A-S, first detector and oscillator; G-58A-S, first I.F.; G-58A-S, second I.F.; G-75, second-detector and first A.F.; G-89, output amplifier; G-6Z5, rectifier. For protection, the primary circuit of the "B" supply and the tube filaments and the field coil of the speaker are supplied with 10-ampere fuses. The receiver is equipped with A.V.C.

The operating voltages of this receiver are as follows:

Tube Type	Plate Volts.	Screen-Grid Volt.	Cathode Volt.	Sup. Grid Volt.	Con. Grid Volt.
V1	110	110	15	1.4	1.4
V2	190	90	3.5	3.5	...
V3	190	90	3.5	3.5	...
V4	135	...	2.25	...	...
V5	170	180	...	...	...
V6	...	180	...	...	...

The above measurements are made from the designated points to ground with a 1000-ohm-per-volt meter, 300 volt range. The "A" battery voltage at the battery should be six volts under load. No signals should be received.

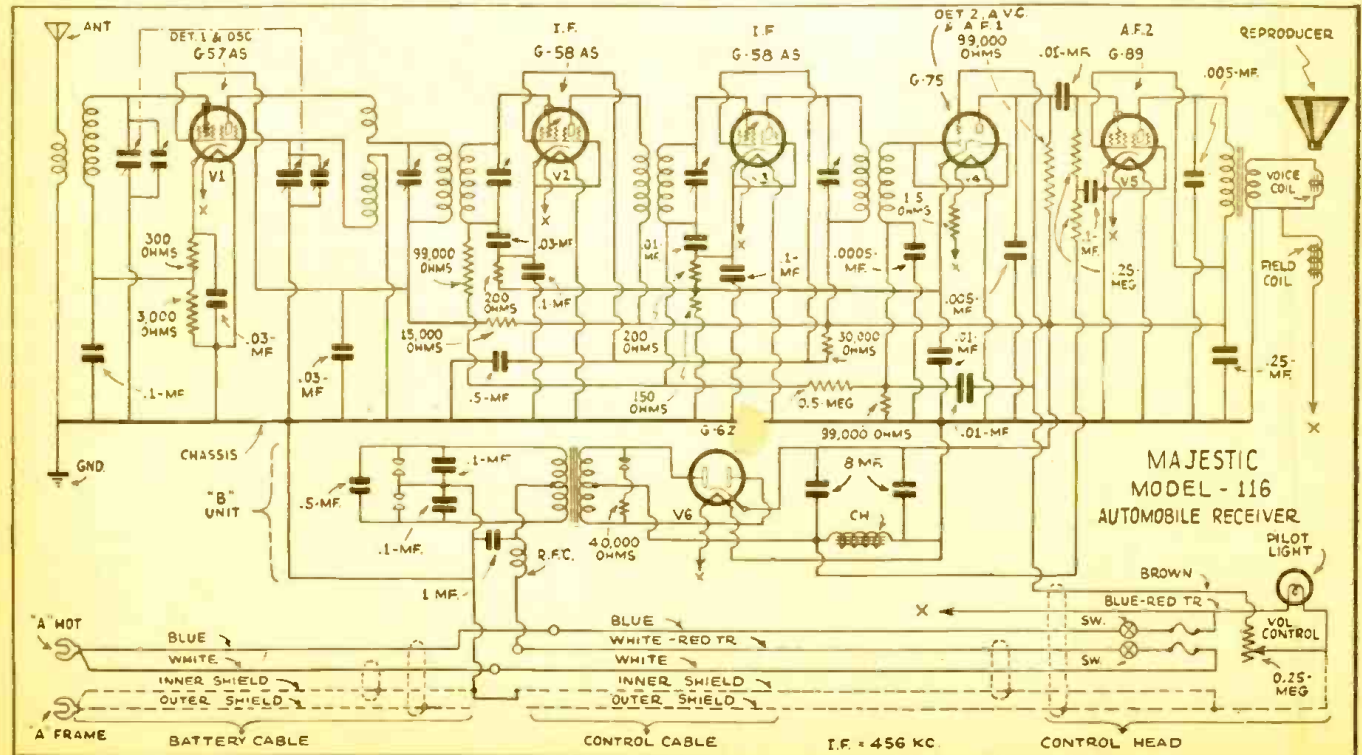
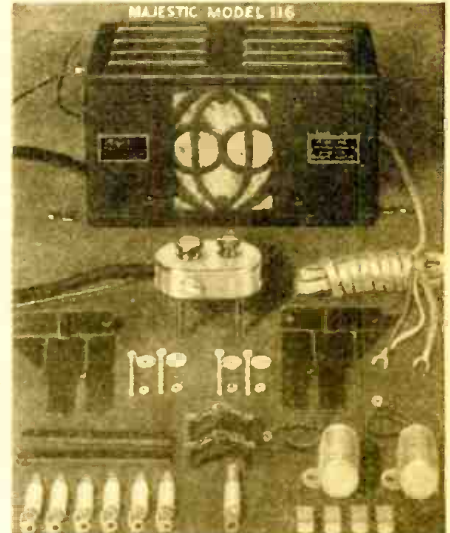
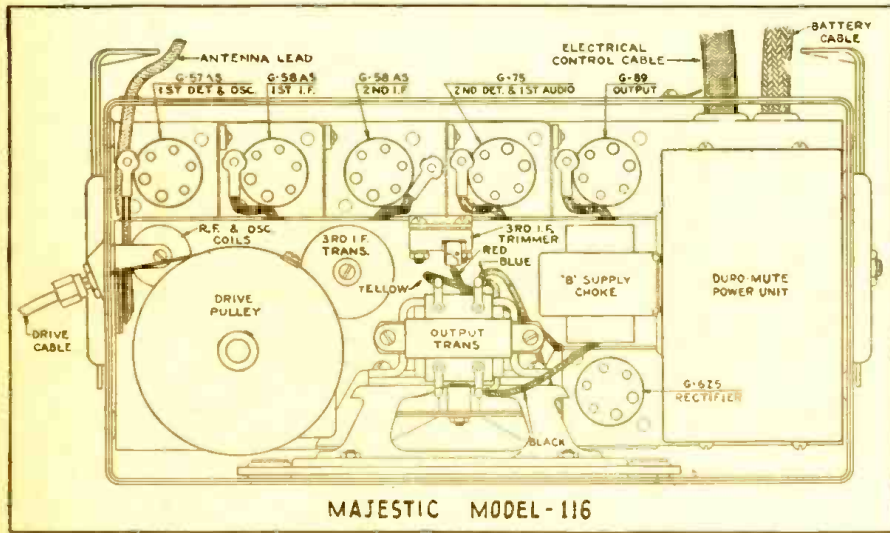
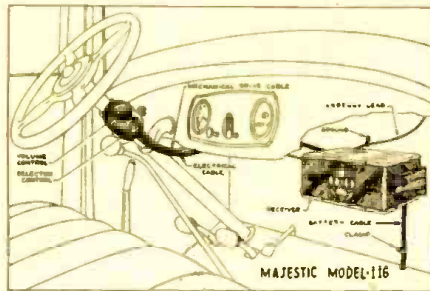







## PHILCO TRANSITONE MODELS 8 AND 12

THESE two receivers are identical except for the fact that the Model 12 is designed for operation from a 12-volt storage battery. The filament connections of the Model 12 are shown here.

The installation data for these receivers are the same as for the Model 7 receiver except for the cable connections: in the Models 8 and 12, the speaker and battery cables and the antenna lead are all formed in a one-piece cable which is totally shielded. The Model EA dynamotor is supplied

as standard equipment on the Model 8 set, and the Model EC dynamotor is supplied as standard equipment with the model 12 receiver. The size of these dynamotors is approximately  $6\frac{1}{2} \times 8\text{-}7/16$  inches.

These receivers are six-tube superheterodynes using the following tubes: one 36 as an R.F. amplifier; one 36 as a combination detector-oscillator; one 36 as an I.F. amplifier (I.F. is 175 kc.); one 38 as a second detector and A. V. C.; two type 41 tubes in the push-pull output stage. The "B" supply is 180 volts. A dynamic speaker is employed. As in other Philco Transitone auto receivers, ignition-noise sup-

pression equipment is supplied as an accessory.

All Philco Transitone Model 12's manufactured after January 1, 1933, are similar to the Model 9, except that they are designed for operation on 12-volt bus and boat batteries.

## PHILCO TRANSITONE MODEL 9

THE Model 9 receiver is a six-tube superheterodyne receiver. The mechanical details are essentially the same as for the Models 7, 8, and 12. The electrical characteristics of this receiver are the same for the Model 6 discussed previously, and, therefore, reference should be made to that description. The tubes used are as follows: One 36 as an R.F. amplifier; one 36 as a combination first-detector and oscillator; one 36 as I.F. amplifier (I.F. is 260 kc.); one 85 as second-detector, A.V.C., and audio amplifier; one 37 in an audio stage; and one 79 in the output stage.

The "B" supply is furnished by a type ED dynamotor which supplies 220 volts.

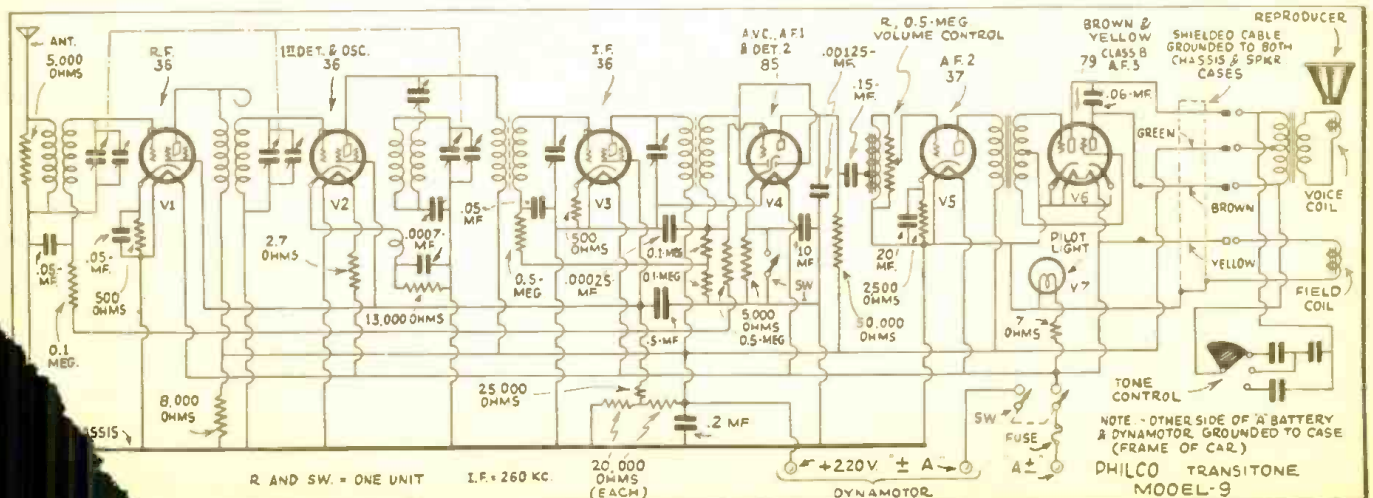
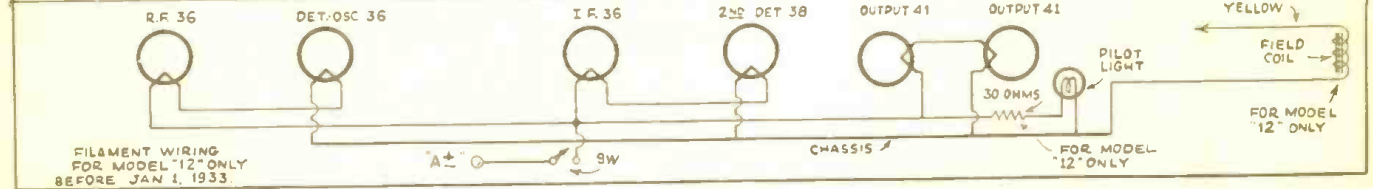
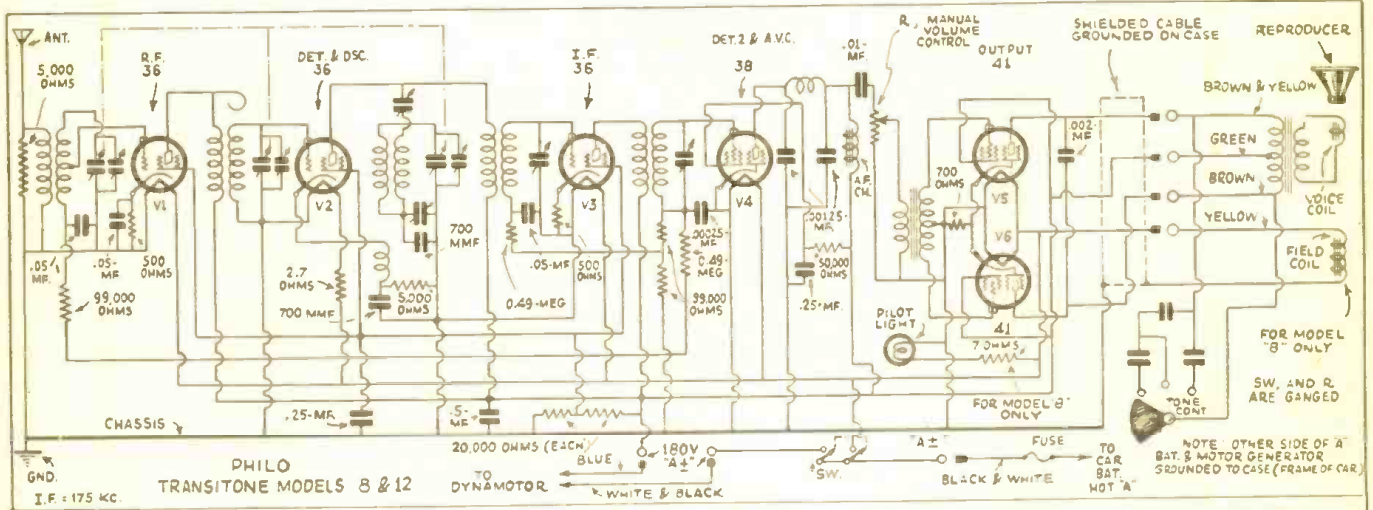
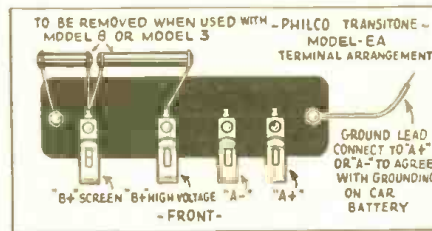
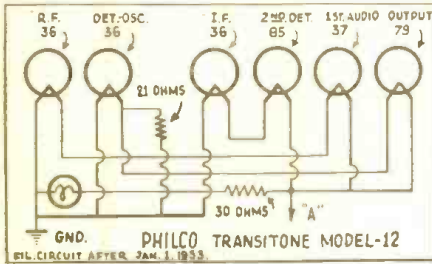



**PIERCE AIRO DEWALD MODEL 52**

An interesting design feature of the Pierce Airo DeWald model 52 Motortone receiver is the inclusion of the receiver chassis, dynamic reproducer, and the "B" eliminator in one complete assembly, as shown in the illustration. An interference suppression kit is furnished with the equipment. The type and arrangement of the antenna is optional with the Service Man. Since most modern cars are factory-equipped with an antenna, this very necessary signal pick-up unit is not included in the standard Motortone offered by Pierce Airo.

The receiver assembly is designed to be mounted on the rear dash under the cowl; just run two leads for the "A," and a third for the antenna, and the job is done. There is supplied with the equipment a template of the four

mounting-stud holes. The illuminated remote control unit clamps to the steering post. When inserting the tubes in the set, the type 37 tube must be inserted before the type 89 tube.

The superheterodyne circuit used in

this set has an I.F. of 175 kc. An A.V.C. connection is incorporated. Tubes utilized: One type 36 tube as combined oscillator and first-detector; one 36, I.F. amplifier; one 85, A.V.C. and second-detector; one 37, first A.F.; and one 89, second A.F.

The "B" unit built into the assembly is of the interrupter type; therefore, do not remove the tubes or the cable plug while the set is on. The "B" rectifier is a type P861.



**PREMIER "AUTO PAL" RECEIVER**

A STANDARD kit of parts, illustrated, for the "Auto Pal" set includes the following items: a 5-tube superheterodyne receiver, tubes, separate dynamic reproducer, steering-column control unit, flexible antenna pad, kit of interference suppressors, distrib-

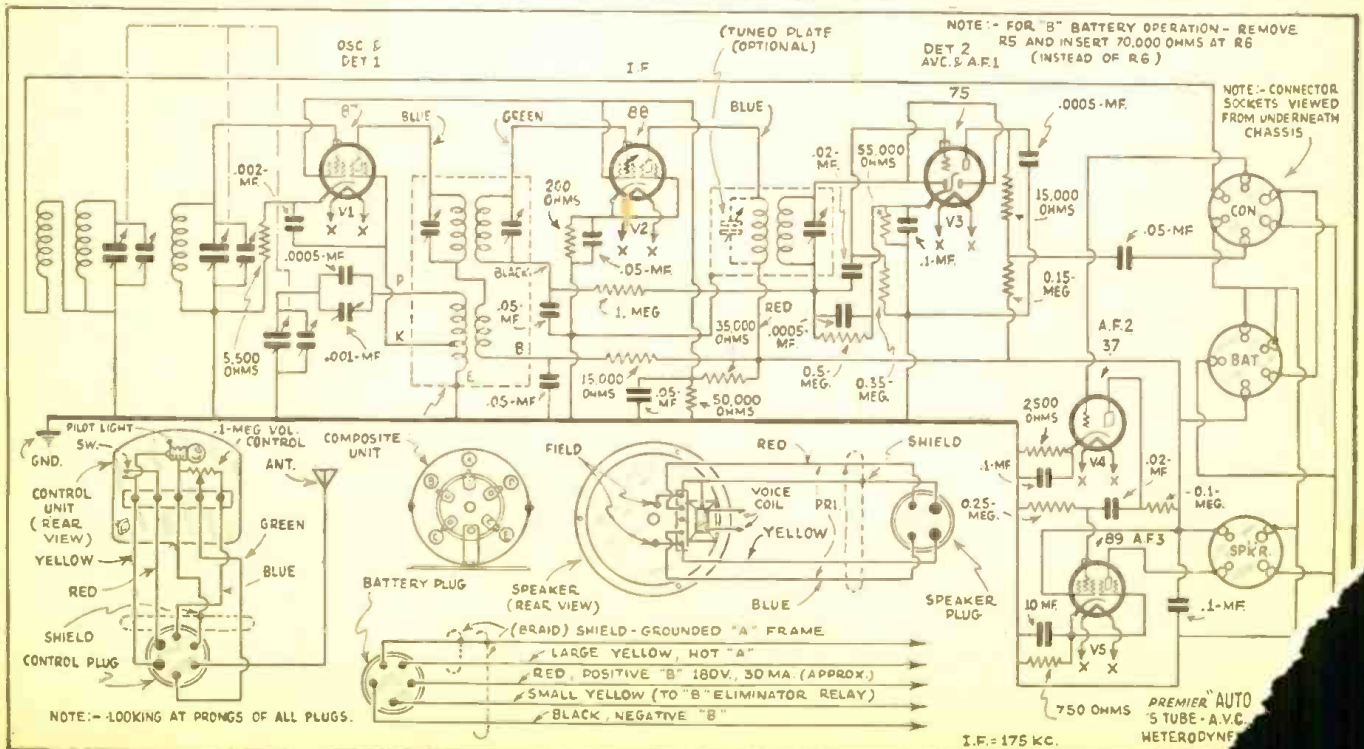
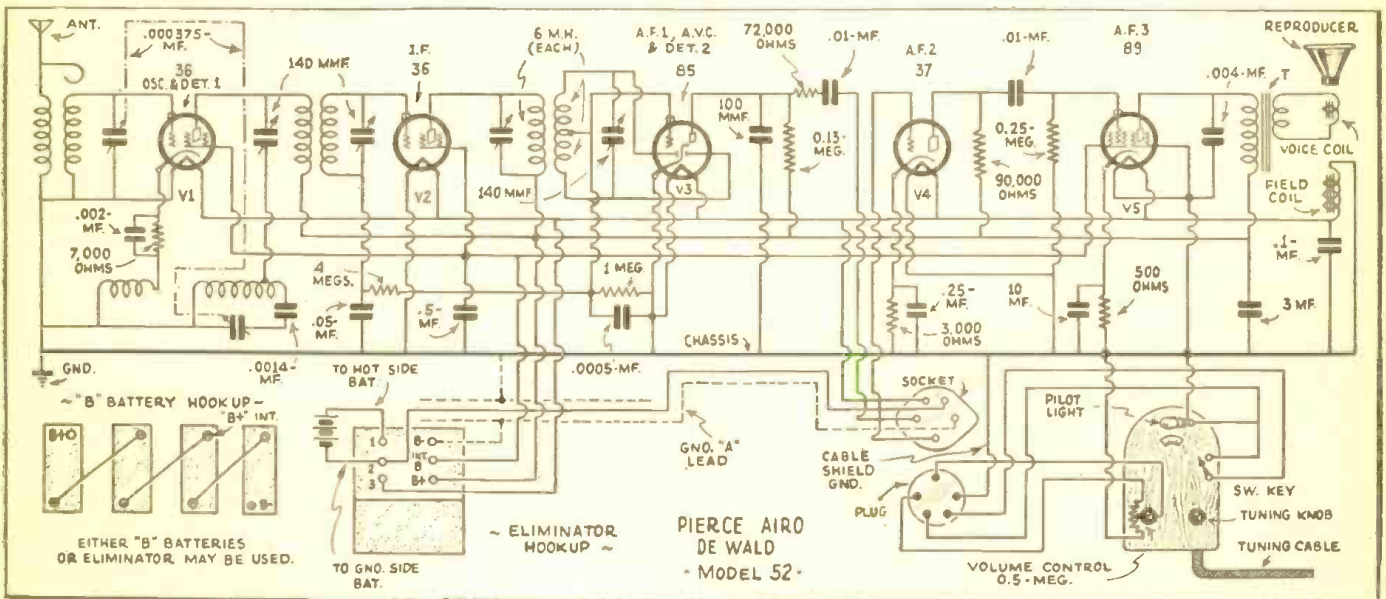



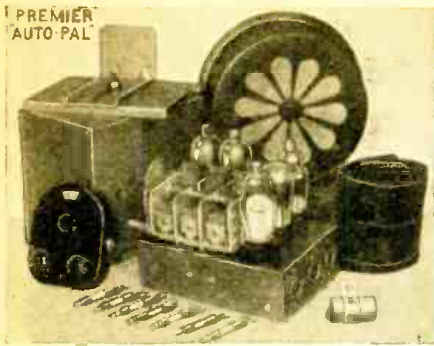

utor filter condenser, and miscellaneous hardware. Individual car designs determine the most suitable place to install this equipment. Provision is made for the "B" supply, which is not included in the standard kit of parts; the "B" voltage may be obtained from batteries or an available Premier "B" eliminator accessory rated at 30 milliamperes and 180 volts.

In this superheterodyne chassis an I.F. of 175 kc. is used. The following tubes are supplied by the manufacturer: One type 87, oscillator-first-detector; one 88, I.F. amplifier; one 75, second-detector and A.V.C.; one 37, first A.F.; one 89, second A.F. The total power consumption at 6.3 volts battery voltage is 33.5 watts. The sensitivity is 2 microvolts-per-meter; the power output, 1.5 watts.

Test voltages for this set are given in the following table; all values are to ground (chassis) and at zero signal input; filament potential, 6.2 volts:

Tube	Position	Cath. Volts	S.-G. Volts	Plate Volts
87	Osc.-Det. 1.....	7	70	150
88	I.F.....	1	70	165
75	A.V.C.-Det. 2.....	3	...	130
37	A.F. 1.....	15	...	180
89	A.F. 2.....	17	180	180

### RCA VICTOR MODEL M-34

A VERY ingenious receiver of advanced design is the new 4-tube RCA Victor model M-34 automotive receiver, which is of the "one-hole mounting" type. The set chassis measures only 8 3/4 x 8 3/4 x 7 3/8 ins. A complete kit of components at the list price includes the following: one receiver chassis, four tubes, remote control unit and cables, six spark plug suppressors, one distributor suppressor, one generator bypass condenser, one ammeter bypass condenser, hard-

ware. Although there is available a special, low-priced, interior-type antenna which may be pinned or otherwise fastened to the roof fabric, it is preferable to operate this set on the built-in antenna with which most modern cars are equipped.

The shield case which houses all the equipment except the control unit is equipped with two spot welded brackets, or mounting plates, one on the back and one on the right side; a heavy bolt with a round head fits into a slot in the brackets, permitting installation of the set on the firewall of the car by the mere drilling of only one small hole. The only operation necessary to let the entire receiver case down to the floor of the car is to lift the hood and loosen two nuts on the bolt. This is an exceptionally easy and quick installation method and should be a powerful sales feature. The side bracket is used in those rare cases where a heater or other obstruction requires a smaller space and when this type of installation is necessary, the firewall space occupied by the set is only 7 3/8 ins. wide and 8 3/4 ins. high. The reproducer is then directed to the right side of the car. However, the small space required for mounting the set with the reproducer directed to the back of the car (toward passengers) is only 8 3/4 ins. high by 8 3/4 ins. wide and this permits of installation to the left of the steering,

post in many cars. Additional details of installation are shown in a photograph.

One mechanical connection, the flexible shaft to the control box, and two electrical connections, the antenna and the cable to the control box, are made in this installation. The flexible shaft controls the tuning condenser and is the only mechanical connection between the receiver case and the control box. This shaft is of special, multiple, reverse-twisted-wire type, made up of 43 small wires encased in a flexible tube. This form of control is so positive in action that it enables the dial to be accurately calibrated in kilocycles. The shaft is 30 ins. long and by cutting it 9, 15, or 21 ins. from the receiver it is thus most conveniently shortened to suit the individual installation, since at these points the shaft is swaged to square cross-section. Three set screws connect the shaft to the control box and receiver case.

The antenna connection is a shielded cable out of the left side of the case and is fitted with a bayonet type of connector, thus eliminating the necessity of soldering and further adding to ease of mounting and demounting.

The only other connection to the case is the electric cable; an eyeletted branch lead connects to the ammeter. Note especially that soldering, and under-floorboard work to reach the battery, are unnecessary. Conse-

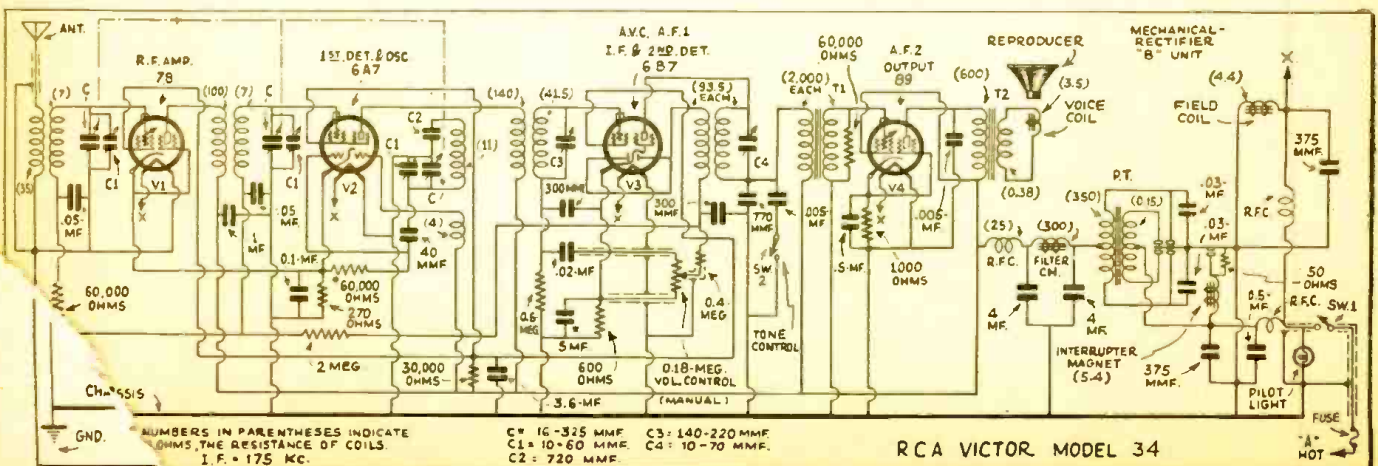
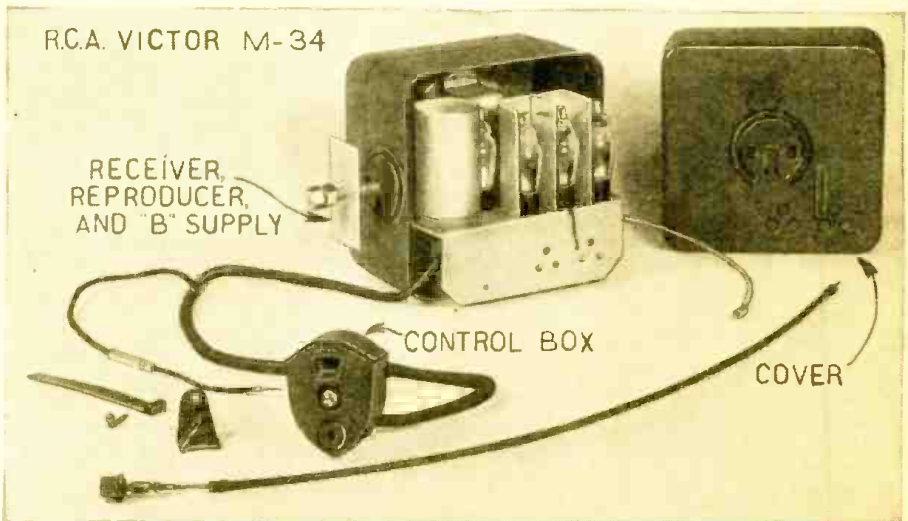



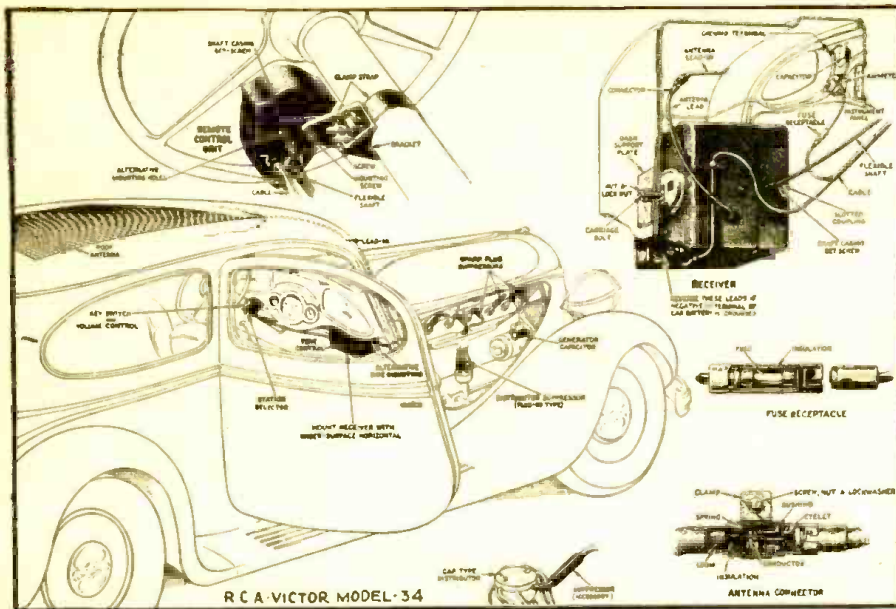

RCA VICTOR MODEL 34

quently, there is no danger of a poor connection or corrosion at the battery terminals, the installation looks neater, and the job is thus made much more easy. (Even the fuse is contained in a special receptacle on the cable to the ammeter, making it particularly accessible for inspection or replacement.)

Removal of six special, slotted hex-head screws permits opening of the receiver case for changing tubes or other service; two each of these screws are located on the bottom and sides of the case. Either a wrench, screw-driver, or a pair of pliers may be used to remove these screws.

The control box is small and new in construction. The dial is illuminated, non-glare, and calibrated in kilocycles—adding a cipher to the (large) dial-numeral indicates the frequency. A small knob controls the tuning; a key, so fitted that it will not fall out in any position, combines the off-on switch

and volume control.

A new type of circular clamp permits installation of the control box on either side, or the front, of the steering column; a low-priced mounting is available as an accessory for mounting the control box on the dash (it is unnecessary to drill holes).

A superheterodyne circuit is utilized in this set; the I.F. is 175 kc. As indicated in the schematic circuit, the following tube combination is used: one type 78 tube as an R.F. amplifier; one 6A7, oscillator and first-detector (also, assists A.V.C. action); one 6B7, second-detector, I.F. amplifier, A.V.C. and first A.F. amplifier. The total "B" current drain of this set is 53 milliamperes; the total "A" drain is 5.6 amperes. The reproducer field current is 1.35 amperes. The undistorted power output is 2 watts; sensitivity, 3 microvolts-per-meter. The maximum D.C.

output from the mechanical rectifier is 250 volts. Tube operating voltage and current figures as follows:

Tube Type	Cath. Volts**	S.-G. Volts	Plate Volts	Plate Ma.
78	3.7	92	253	7
6A7 <sup>1</sup>	3.7	92	257	12
6A7 <sup>11</sup>			253	total
6B7	3.2		236	6
89	26.5	257	244	27.5

(Filament terminal voltage, all tubes, 6.06 volts. \*Measured to cathode; \*\*to ground. <sup>1</sup>First-detector; <sup>11</sup>oscillator.)

Much of the efficiency obtained in this receiver design is due to the use of two new tubes known as the pentagrid converter (the 6A7), and the duodiode-pentode amplifier (the 6B7). Automatic volume control is incorporated in this set. Also, there is a two-position tone control mounted on the front of the receiver case; this control adapts the set reproduction to the acoustic characteristic of individual car installations; the frequency range is 150 to 3,500 kc.

As previously stated, the reproducer and "B" sections of the receiver are contained in the receiver chassis; this "B" supply is best described as a "mechanically self-rectified interrupter-type" unit; it does not require a tube rectifier. The design necessitates double shielding, both mechanically and electrically; two heavy screw-covers telescope one over the other, and inside shield-partitions further segregate the circuits. This type of interrupter-"B" has a very low current drain and, in fact, even will function when the "A" voltage is considerably below normal.

### SENTINEL "A.C.-D.C." MODEL 561

PERHAPS the most interesting feature of this ultra-midget 5 tube set, illustrated, is its adaptability to the current supply, whether the available power is a 110 volt, A.C. or D.C. light line, a 32 volt farm lighting system, or the 6 volt storage battery in an automobile.

Included with the set are only the

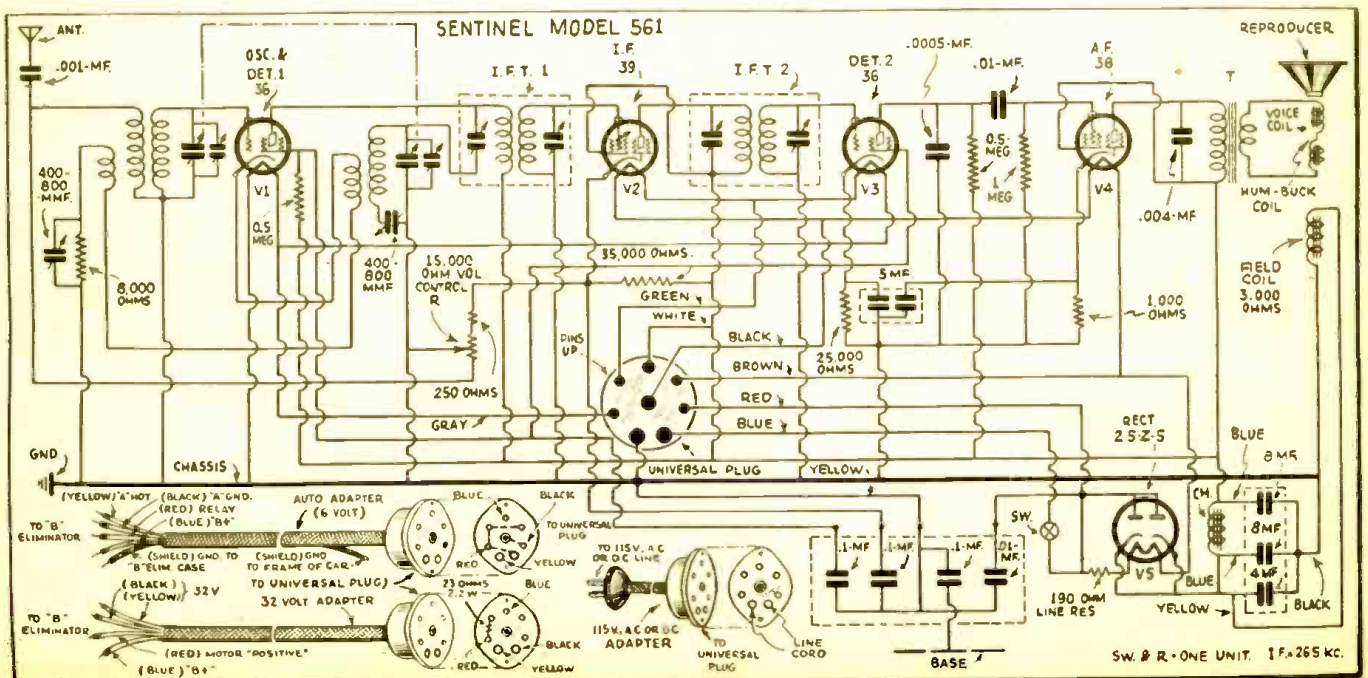



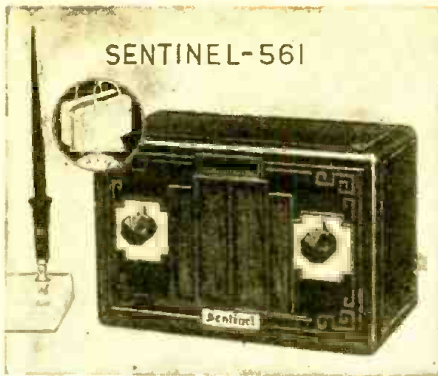

SENTINEL-561

tubes, dynamic reproducer integral with the set, and a 25-foot reel of antenna wire. However, the following accessories are available: a special Sentinel 125 volt, 60 milliamperer interrupter-type "B" unit, car antenna, 6-volt adapter cable and plug, spark plug and generator suppressors, generator filter condenser, and mounting bracket assembly, web strap and buckle.

The receiver may be mounted in any convenient place in the automobile such as the robe rail in back of the front seat, between the dashboard and windshield pane, or on the underside of the dashboard head. Mounting accessories are available for this purpose.

In this receiver we find a superheterodyne circuit designed for A.C.-D.C. operation; the I.F. is 265 kc. Tubes used: One type 36 oscillator-first-detector; one 39, I.F. amplifier; one 36, second-detector; one 38, A.F. amplifier; and one 25Z5, rectifier. Total "B" requirement, about 60 milliamperes at 125 volts; a 90-volt block of "B" batteries may be used. The reproducer has a 3,000 ohm field.

Tube Type	Tube Position	Plate Volts	S.-G. Volts	C.-G. Volts
36	Osc.-Det. 1	112	25	2.5
39	I.F.	112	112	2.9
36	Det. 2	28*	25*	2.0
38	A.F.	108	112	1.5*
25Z5	Rect.			

\*Approximate. \*\*Total current output, 52.5 milliamperes.

### SPARTON MODEL 34

THE Sparton model 34 automotive receiver is a seven tube superheterodyne employing the Lafoy system of automatic volume control, pentode push-pull power output, and is equipped with finger tip remote-control tuning; the tuning control box is located on the steering column.

The receiver comes equipped with tubes but without accessories: the accessories include batteries and ignition suppressors. Either a wire mesh or a capacity-plate antenna may be used.

The mechanical arrangement of the set is such that it may be mounted either on the dash or under the floorboards. The dynamic speaker, aside from the more conventional arrangement, may be mounted under the floorboards so that the grille is flush with the floor, like a heater.

Reference to the schematic circuit will show that a 39 is used as the first R.F.; a 36 as a combination detector-oscillator; a 39 as the I.F. amplifier tuned to 172.5 kc.; a type 70 second-detector and A.V.C. tube; a 37 in the first A.F. stage; and two type 38 pentodes in the output.

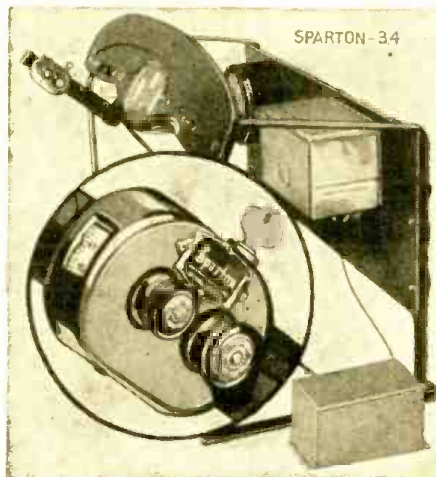

SPARTON-34

The battery equipment necessary, aside from the storage unit, is four 45 volt "B" batteries and a small "C" battery. The operating voltages and currents are as follows:

Tube Type	Plate Volts	Cont. Grid Voltage	Screen-Grid Voltage	Plate Curr.
V1	90	3.0	90	4.0
V2	120	15.0	90	2.0
V3	90	3.0	90	4.0
V4	180	...	...	1.0
V5	125	10.0	...	4.0
V6	180	19.5	180	8.0-10
V7	180	19.5	180	8.0-10

The above data are valid only when the condition of the batteries is good and the volume control is set to maximum with no signal.

A photograph of the equipment and a pictorial view of the receiver showing the location of all parts are appended.

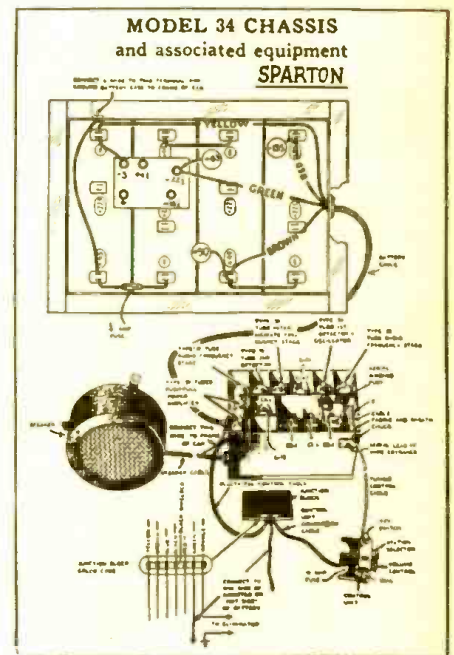

MODEL 34 CHASSIS and associated equipment SPARTON

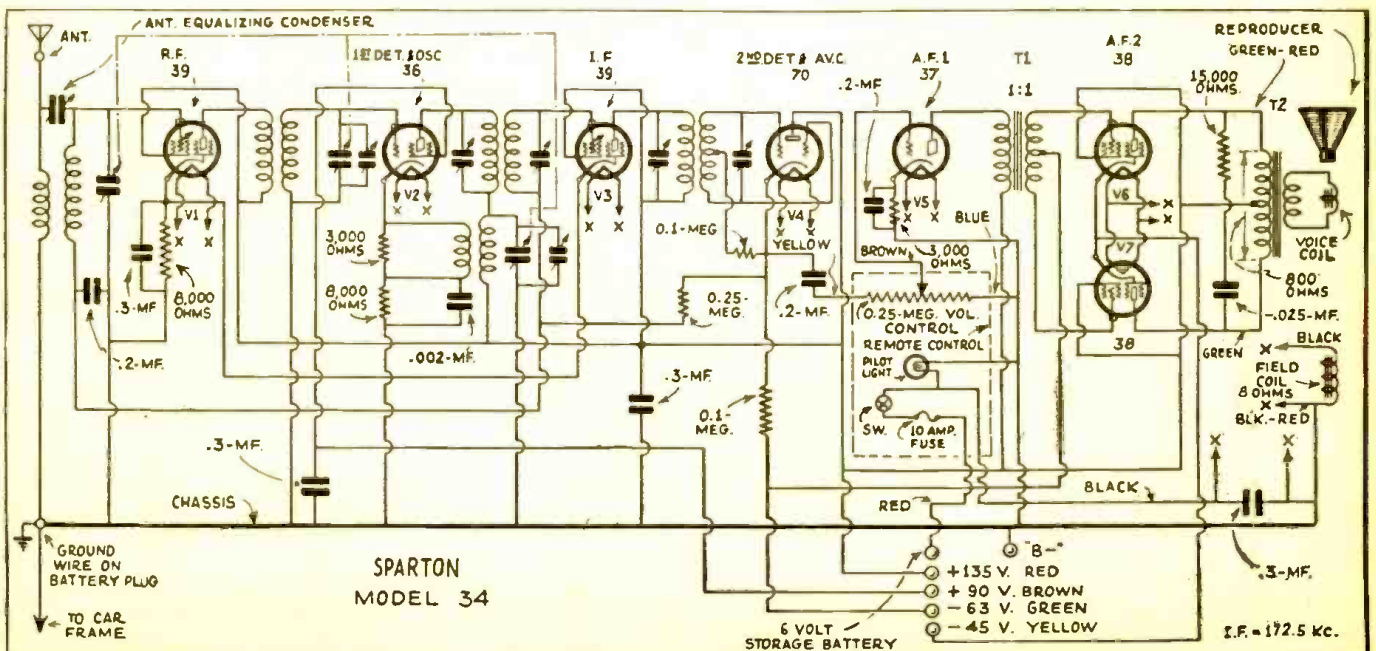



## STEWART "ARISTOCRAT"

THE Stewart "Aristocrat" is similar to the Stewart "Companion," here described, in many respects; the mechanical considerations are the same; but the electrical characteristics are different.

The sensitivity of this model is, also, 1 microvolt, measured by R.M.A. standards; the tubes used are as follows: a 39 as an R.F. amplifier; a 36 as a combination detector-oscillator; a 39 as an I.F. amplifier; an 85 as a combination second detector and A.V.C.; a 41, class A audio driver; a 79, class B power output tube; and an 84 rectifier. The "A" battery consumption of the set is 5.5 amperes at low signal levels, and 6 amperes at maximum power output.

The components of the "Aristocrat" and the "Companion" are completely interchangeable with the exception of the audio system and the "B" supply transformers.

## STEWART "COMPANION"

THE Stewart Companion is a six-tube receiver of the superheterodyne type. It is 9 1/2 inches wide, 6 1/2 inches high, and 5 1/2 inches deep. It is equipped with a remote tuning-control box, a combination "B" unit and

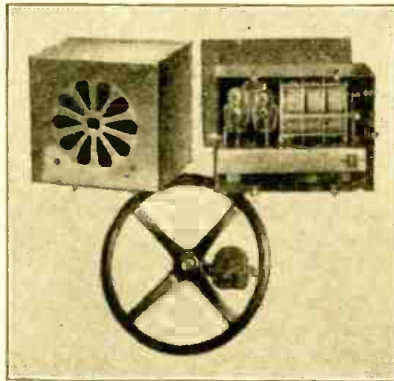

speaker, and a receiver. The accessories are part of the car: they consist of all suppressors, condensers, bolts, washers, etc. The more conventional antennas may be used.

The receiver is designed to mount on the bulkhead, on either the engine or driver's side. The combination speaker and "B" unit mounts with a single bolt. The speaker should be so mounted that it may be adjusted, by means of the provisions provided, to suit the acoustic characteristics of the car, depending upon whether the car is crowded or not. Stewart Radio & Television Co. calls this feature "floating control."

As previously stated, the "Companion" is a six-tube superheterodyne using one 39 as an R.F. amplifier; a 36 as a composite detector-oscillator; a 39 as an I.F. amplifier; an 85 as a combination second-detector and A.V.C.; a 41 output pentode; and an 84 rectifier. The I.F. is 175 kc. The total current

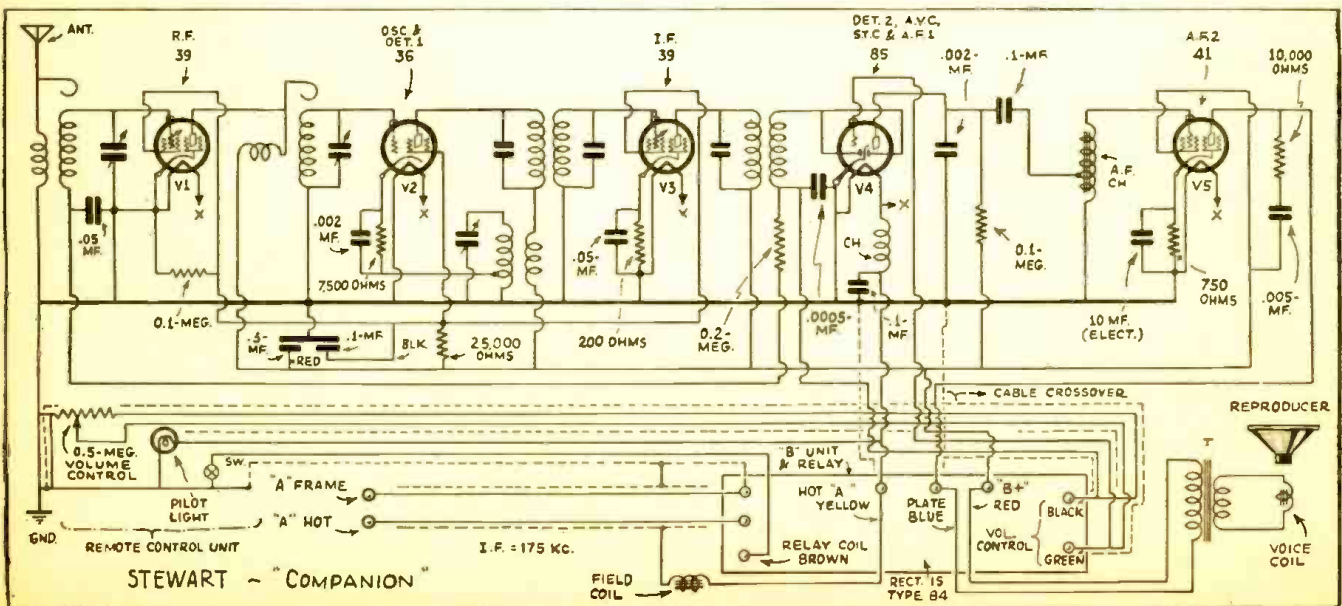
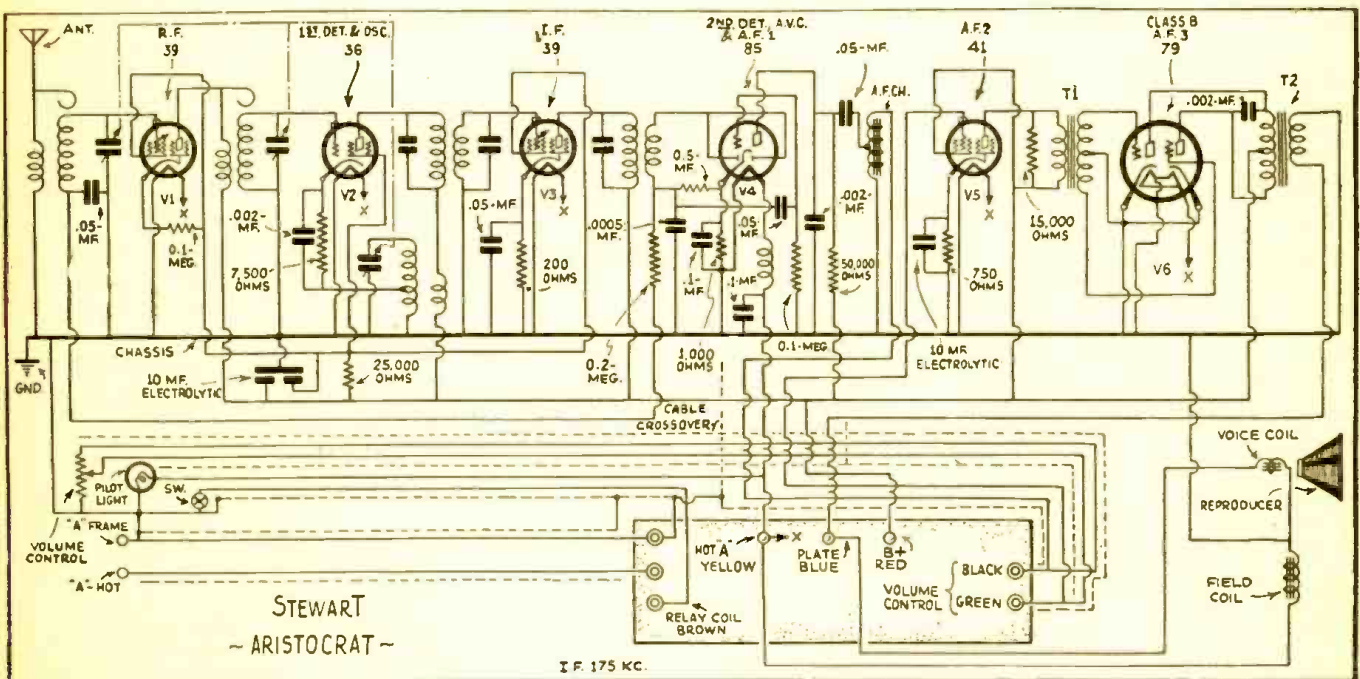



consumption of the set is five amperes at 6.3 volts; the sensitivity is 1 micro-volt per meter, maximum, measured by R.M.A. standards; and the power output is 1.5 watts.

The receiver is equipped with manual quiet A.V.C., which the manufacturer calls "QAVC."

### "TOM THUMB" STEERING POST SET

TO MEET the demand for a quickly installed automotive radio set the Automatic Radio Mfg. Co. has added to their "Tom Thumb" line a Steering Post Auto Radio Set; this instrument and the accessories which are supplied to complete the ensemble are illustrated. Although the operating system includes four tubes, only three—the two R.F. amplifiers and the detector—are incorporated in the unit which mounts on the steering column (holes in the tuner case permit either left- or right-side mounting). The case of this "tuner" measures about  $5 \times 5 \frac{1}{2} \times 5 \frac{1}{2}$  ins. deep. The remaining tube, the A.F. amplifier, is contained in the dynamic reproducer chassis, as shown in one of the views; the case of this component measures  $4 \frac{1}{2} \times 8$  ins. diameter (about 10 ins., over all). These two units connect together by means of a cable which plugs into the tuner.

A complete installation at the list price includes: a steering-column tuner (with illuminated, full-vision dial, volume control, and off-on switch), an amplifier-reproducer, shielded junction cable and plug, shielded power cable, steering-column clamp, tubes, spark plug suppressors, distributor suppressor, generator bypass condenser, and hardware. Not included in the factory kit are the antenna and the "B" unit; either batteries, or any of the conventional "B" units with a voltage output within the range of 135 to 180 volts, may be used as power supply.

Clamping the tuner to the steering post eliminates the necessity for running-control wires to a remote-control unit. By removing from the tuner chassis the L-shaped cover-plate, or from the reproducer chassis the cover-disc, the interior of these two units is available for replacing tubes—without the necessity of removing either of these chassis. The amplifier-reproducer chassis brackets may be bent to conform with irregular bulkheads or floorboards.



Referring to the diagram it is seen that this diminutive set, a literal "Tom Thumb" in automotive radio receivers, incorporates the following tube arrangement: one type 78 tube as an untuned R.F. amplifier; one 78 tuned R.F. amplifier; one 77, detector; one 41, A.F. amplifier. The total "B" current consumption is 28 milliamperes at 180 volts, or 18 at 135; the "A" drain (tube heaters and reproducer field) is 2.7 amperes; the total storage battery drain for "A" and "B" (using a good, standard "B" unit) is less than 4 amperes. The Tom Thumb set has a sensitivity of about 4.5 microvolts at 1400 kc., about 40 at 750 kc., and about 20 at 600 kc.

The power cable has three main leads: hot, or ungrounded "A" (HA, in diagram), a "B" positive lead which taps to a 135 to 180 volt current source (the higher voltage will result in improved volume and tone quality), and a shield lead GA for the "B" negative and grounded "A." The leads from the dynamic reproducer are shielded. A special terminal, X, is provided in the reproducer and is connected to the "live" side of the heaters. This wire is required for controlling the "B" supply or motor-generator unit which is not equipped with relays. A shielded lead run from this terminal to the supply device, and grounded at each end, will enable the "B" unit to be turned on

or off with the switch on the front of the set.

Many Service Men prefer to use a dynamotor rather than batteries or an "eliminator" to supply the required "B" voltage.

The dynamotor shaft *must* be placed in a horizontal position.

Check the polarity of the dynamotor leads by means of a voltmeter. If the precaution of pre-determining the polarity of the dynamotor leads is not followed, the shielding of the hot "B" lead, being grounded, will short the output circuit of the dynamotor and perhaps permanently damage it; or, the set will not operate. If the leads to the storage battery are reversed, the storage battery will be shorted, due to the hot "A" lead shield being grounded, and the car battery thus may be permanently damaged.

To determine whether interference is due to noise pick-up by the flat-top or lead-in sections of the antenna system, remove the lead-in from the antenna, or substitute for the lead-in a short length of wire running in the same direction as, and the same length as, the regular lead-in. If the noise stops, it indicates that the flat-top portion of the antenna is picking up the interference.

### UNITED MOTORS SERVICE (GENERAL MOTORS) MODEL 2035 (U. S. RADIO & TELEVISION)

CONTROL panel, receiver chassis, dynamic loudspeaker, and power supply are all individual units. The control box is designed for mounting under the edge of the instrument board rather than on the steering column. The other parts fit most conveniently behind the instrument board. Plug connections between the units facilitate installation.

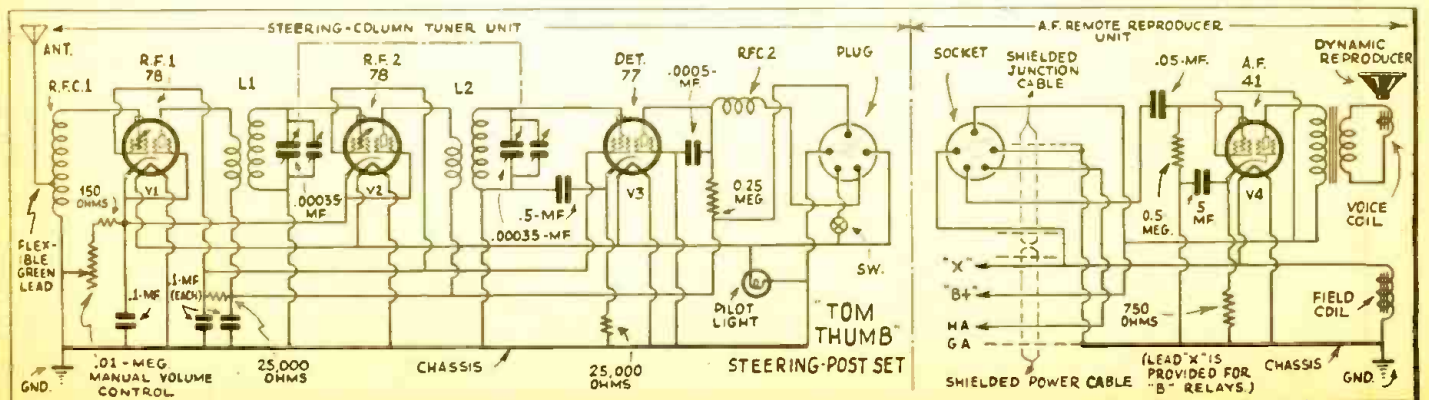







An I.F. of 262 kc. is used in this superheterodyne. The diode A.V.C. circuit tends to equalize the intensity of all carrier signals to a point predetermined by the setting of the manual volume control, at the same time automatically compensating for any variation in the carrier signal strength such as is usually experienced when driving past large steel buildings or under viaducts. This feature further eliminates the blasting effect when tuning from weak to strong local signals and adds materially to the life of the pentode tube by reducing the likelihood of overloading the A.F. circuit.

The tube arrangement is as follows: one type 78 tube as R.F. amplifier; one 77, oscillator and first-detector; one 78, I.F. amplifier; one 75, A.V.C. and second-detector; one 41, A.F. amplifier; one 84, rectifier.

The "A" consumption is 4.85 amperes. The sensitivity is 0.5-microvolt-per-meter; selectivity, 20 kc.; power output, 1 watt. The tone quality has been adjusted to a fixed value by means of a bypass condenser in the plate circuit of the A.F. pentode.

All components may be examined and serviced by removing the two bottom screws of the container and the bottom plates. The circuit of the interrupter-type "B" unit is not shown in its entirety in the schematic diagram.

### ZENITH MODEL 460

CONSISTS of two units: a small one containing the directly connected tuning controls and the first tube (a combined oscillator and first detector), intended for mounting on the steering column; and a larger one containing six tubes, the loudspeaker and the plate power unit, for either steering column or bulkhead mounting. Lock switch, ignition suppressors and all mounting hardware supplied; antenna not included.

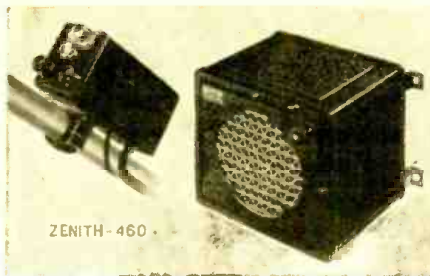

Seven-tube superheterodyne circuit with automatic volume control. Tubes: one 85, two 89's, two 6D6's, one 6C6, and one 6Z4. Autodyne first detector, two stages of 485 kc. I.F., duo-diode

second detector, push-pull output, dynamic speaker with tone control. Current drain 6, amperes; fused battery lead. Sensitivity 1.5 m.p.m. Plate supply device of interrupter type, with step-up transformer and full-wave rectifier tube.

### Tube Operating Voltages

Position	Tube	E <sub>f</sub>	E <sub>k</sub>	E <sub>g1</sub>	E <sub>g2</sub>	E <sub>g3</sub>	E <sub>p</sub>
1st Detector...	6C6	4.8	6.5	0	6.5	120	150
1st I. F. ....	6D6	5.3	10.5	*	10.5	103.5	165
2nd I. F. ....	6D6	5.3	10.5	*	10.5	103.5	165
2nd Detector...	85	5.3	8.0	0			156
Push-Pull Audio	89	5.3	17.0	0	17.0	165.0	165
	89	5.3	17.0	0	17.0	165.0	165

f = filament. k = cathode. g<sub>1</sub> = suppressor grid. g<sub>3</sub> = screen grid. p = plate. g<sub>2</sub> = suppressor grid.

\*This voltage depends on the applied signal strength.

All voltages are measured from indicated points to ground.

### APRIL FOOL!

The revolutionary (?) seven-tube Superhetero-Ultradyne

It is too bad that the several hundred readers, who had written in hastily for additional information as to where they could buy this now famous set, did not take the trouble to read the entire article. They probably just glanced at it and jumped to the conclusion that this was a real set.

Inasmuch as the May issue usually makes its appearance about the 1st of April, the veteran Ulysses Fips, the perpetrator of many radio jokes during the past twenty years, had thought it appropriate to play one of his customary jokes on his radio readers. He was more than successful in this one, because all too many readers took him seriously and either wanted to know where the Westing-Mouse set could be purchased, or where the parts and tubes, at least, could be obtained.

Needless to say, the set only exists in a single model built by Fips himself, from various junk parts. The miniature "vacuum tube" some readers may have recognized as an ordinary 6-volt pilot lamp such as is used in radio sets.

### PHILCO TRANSITONE DYNAMOTORS

In all there are five dynamotor models with characteristic differences. Model EA 6.3V. primary, 40 milliamperes at 180 V. (67 1/2 V. tap.) Model EB 6.3V. primary, 40 milliamperes at 180 V. Model EC 12.6V. primary, 40 milliamperes at 180 V. Model ED 6.3V. primary, 40 milliamperes at 220 V. Model EE 12.6V. primary, 40 milliamperes at 220 V.

#### Standard Equipment

- Philco Transitone Model 6—Dynamotor EB.
- Philco Transitone Model B6—Dynamotor EB.
- Philco Transitone Model 7—Dynamotor EA.
- Philco Transitone Model 8—Dynamotor EA.
- Philco Transitone Model 9—Dynamotor ED.
- Philco Transitone Model B9—Dynamotor ED.
- Philco Transitone Model 12 (121)—Dynamotor EC.
- Philco Transitone Model 12 (122)—Dynamotor EE.
- Packard Car Radio—Dynamotor ED.

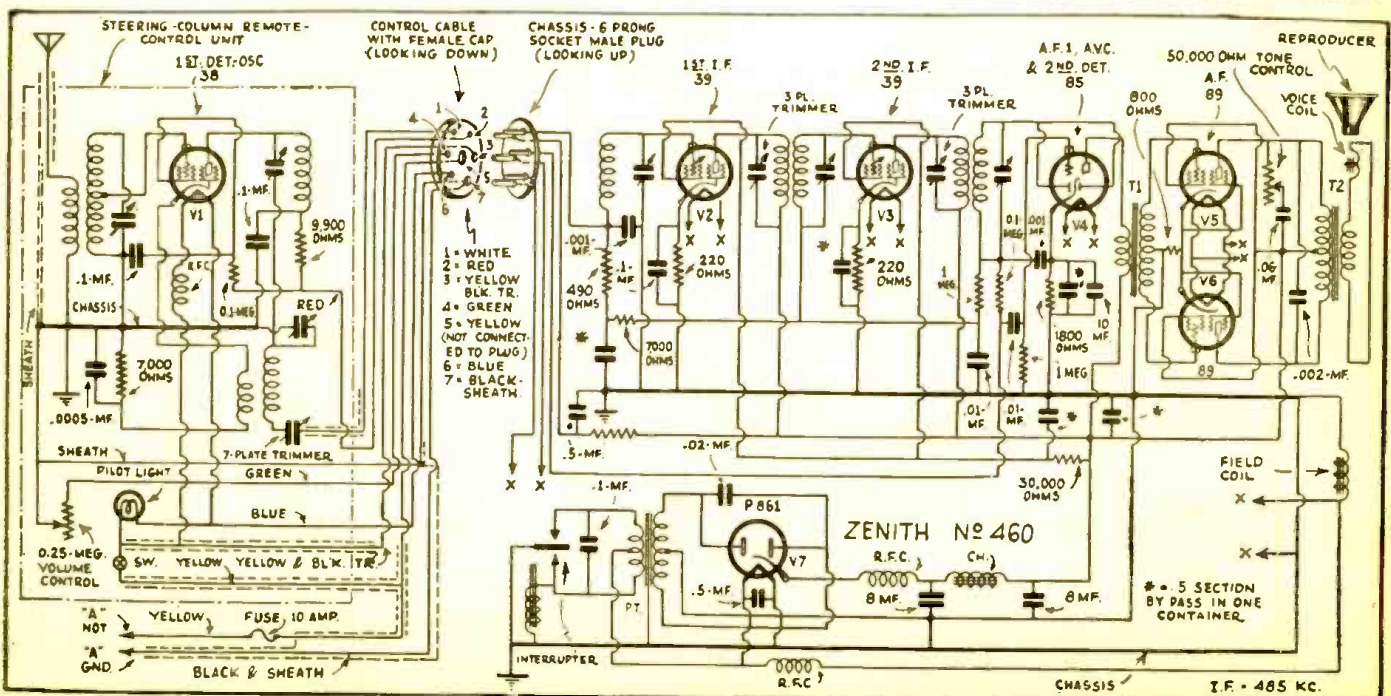



# THE DX LISTENER'S FORUM

This department is devoted exclusively to the DX radio listener of the broadcast band. In this department are letters from those listeners who achieve unusual results in long-distant reception. We invite all readers of this magazine to forward their list to us for publication. Only the best lists will be published.

## OUR PENTODE PORTABLE

Editor, RADIO-CRAFT:

I wrote to you telling of the results obtained with my "Pentode Portable" described in your September, 1931 issue. Here is a list of stations received on the dynamic speaker during July and August; all city stations: WJZ, WABC, WEAF, WOR, WPG, WGY, WLW, WCAM, WEEU, WBZ, WRC, CFAC, CKCL, WAPI, WJAX, WHAS, WTIC, WTAM, WLS, WENR, KDKA, WBAL, WBT, WRVA, WDEL, WRUF.

JOHN FOSTER.

5938 Sansom St., Philadelphia, Pa.

## NOT BAD, EH?

Editor, RADIO-CRAFT:

My first experience with broadcast receivers dates back a few years ago when I was using a one tube, regenerative receiver. The tube used was a type 201A. The "B" source was a 45-volt Eveready unit. The "A" battery was a 6 volt "hot shot." With a pair of Baldwin headphones, an aerial approximately 100 feet long and a pump pipe for a ground, I managed to pull in oodles of stations from various parts of the country.

Here is a list of some of the stations received: WAPI, WBAL, WBT, KTBS, WFLA, WSUN, WRUF, WJAX, WQAM, WIOD, WDBO, WDAE, WSB, WENR, KDKA, WLS, WCCO, WOWO, WHAS, WWL, KWKH, WPG, WOR, WEAF, WJZ, WLWL, WGY, KRLL, WLW, WEAN, KVOO, WSM, WRVA; and last, but not least, KFI, in Los Angeles. I consider that a record as it is approximately 2,000 miles airline from my location (Ocala) to that city. I also received WLW in July at noontime on this same outfit. Later in the afternoon, I picked up WCCO and WEAN. Both signals came in with fair volume. In these last two instances I was eleven miles from Ocala, west of Summerfield, Fla. This is in the country away from all man-made electrical interference. At this same location I received CMK in Havana, Cuba, and another unidentified station somewhere in Hawaii.

SIMON H. SASSER.

P. O. Box 46, Hawthorne, Fla.

## OH BOY!

Editor, RADIO-CRAFT:

I have just seen your new DX section in RADIO-CRAFT, and as I have been getting what I consider very good results with a 5-tube T.R.F. set I constructed two months ago, I decided to let you know what two 34s, two 30s, and one 33 have done for me. Using an indoor aerial and this battery set I have received the following stations, hearing the call letters of each one clearly: CKOK, Windsor; WGR, Buffalo; WKRC, Cincinnati; WLIT, Philadelphia; WQAM, Miami; WMCA and WNYC, New York; WEEL, Boston; WCAC, Storrs, Conn.; WCAO, Baltimore; WICC, Bridgeport, Conn.; WIP, Philadelphia; WTMJ, Milwaukee; CKOC, Hamilton, Ont.; WMAL, Washington, D. C.; KFI, Los Angeles; WSM, Nashville; WEAF, New York; WMAQ, Chicago; KPO, San Francisco; WPTF, Raleigh, N. C.; CFRB, Toronto; WLW, Cincinnati; WOR, Newark; WGN, Chicago; CKAC, Montreal; XER, Villa Acuna, Mexico; WSB, Atlanta; WJR, Detroit; WBAL, Baltimore; WJZ, New York; WBBM, Chicago; WEAN, Providence, R. I.; WTAR, Norfolk, Va.; WGY, Schenectady; WBAP, Fort Worth, Tex.; WFAA, Dallas, Tex.; WCCO, Minneapolis; WPCB, New York; WHAS, Louisville, Ky.; KOA, Denver; WHDH, Boston; CKGW and

CPRY, Toronto; KWKH, Schreveport, La.; WABC, New York; WENR, Chicago; WLS, Chicago; WGBI, Scranton, Pa.; WILL, Urbana, Ill.; WJAR, Providence, R. I.; WMMN, Fairmont, W. Va.; WBEN, Buffalo; WJAX, Jacksonville, Fla.; WKY, Oklahoma City, Okla.; XEW, 5,000 watts, Mexico City; KPRC, Houston, Tex.; WWJ, Detroit; WDBJ, Roanoke, Va.; WAAT, Jersey City, N. J.; WCSH, Portland, Me.; WFIW, Hopkinsville, Ky.; KMBC, Kansas City, Mo.; WRC, Washington, D. C.; XED, Reynosa, Mexico; WCFL, Chicago; KDKA, Pittsburgh, Pa.; WBZ-WBZA, Boston; WHO, Des Moines; WOC, Davenport; WORK, York, Pa.; WHN and WRNY, New York; WIS, Columbia, S. C.; KYW, Chicago; WRAX, Philadelphia; CFCF, Montreal; KRLL, Dallas, Tex.; KTHS, Hot Springs, Ark.; WESG, Elmira, N. Y.; KNX, Hollywood; WTIC, Hartford, Conn.; WTAM, Cleveland; WBT, Charlotte, N. C.; WMBI, Chicago; KMOX, St. Louis; WLWL, New York; WPG, Atlantic City, N. J.; WRVA, Richmond, Va.; WDEL, Wilmington, Del.; KSL, Salt Lake City, Utah; WJJD, Chicago; WOV, New York; WAPI, Birmingham, Ala.; WHAM, Rochester, N. Y.; WOWO, Fort Wayne, Ind.; WWVA, Wheeling, W. Va.;

N. Y.; WGES, Chicago; WJKS, Gary, Ind.; WGLC, 50 w., Hudson Falls, N. Y.; WSVS, 50 w., Buffalo; KQV, Pittsburgh; KLRA, Little Rock, Ark.; WHK, Cleveland; WBBC, WCGU, and WLTH, Brooklyn, N. Y.; WAAB, Boston; WRBX, Roanoke, Va.; KFIZ, Fond du Lac, Wis.; WAGM, Presque Isle, Me.; WAZL, Hazlet, Pa.; WHFC, Cicero, Ill.; KECA, 1000 w., Los Angeles; WCAH, Columbus, Ohio; WHEC, Rochester; WHP, Harrisburg, Pa.; WOKO, Albany, N. Y.; WCBA, Allentown, Pa.; WMBD, Peoria, Ill.; WHOM, Jersey City, N. J.; WNJ, Newark, N. J.; KSTP, St. Paul, Minn.; WJSV, Washington, D. C.; KGA, Spokane, Wash.; WLAC, Nashville, Tenn.; KOMA, Oklahoma City, Okla.; WKBW, Buffalo; WCKY, Covington, Ky.; WMIL, Brooklyn, N. Y.; WPEN, Philadelphia; WRDL, Augusta, Ga.; WSYB, Rutland, Vt.; WRRW, Woodside, N. Y.

As you can see from this list I have received several stations from California and the Pacific Coast as well as four Mexican stations. There are also 50 watters from as far as Michigan and a 100 watter in Alabama. Considering that I use only an indoor aerial, I think I am justified in being proud of my set's performance. It was originally designed by me for listening to programs when my D. C. set was humming badly, as it does at times, and I was surprised at the number of stations pulled in. New ones came in every night; four yesterday. If you would be interested in a diagram of this set, which is more or less of accepted two-stage R.F. grid leak detector, and two-stage audio design, I would be glad to send you a copy, but I cannot promise to answer too many letters as I would rather tune than write. I used standard parts, similar to those in small A.C. sets, and have completely shielded the set and tubes. My next experiment will be to substitute a 32 detector for the 30 I am now using.

GEORGE H. BALDWIN, JR.,  
3439 Yale Station,  
New Haven, Conn.

## AND FROM FRANCE

Editor, RADIO-CRAFT:

I am reading with much pleasure your RADIO-CRAFT, in France, which is the best radio magazine I have ever seen. I have received a lot of

American stations with my set (11 tubes): four 58's, three 56's, one 57, two 47's, and one 80; with "Flashograph Automatic." The following is a list of stations received in France: WJR, Detroit, Mich.; WRR, Dallas, Tex.; WTAM, Cleveland, Ohio; KFI, Los Angeles, Calif.; KGB, Los Angeles, Calif.; WAAT, Jersey City, N. J.; WACO, Texas; WBAL, Baltimore, Md.; WBBM, Chicago, Ill.; WBIS, Boston, Mass.; WBOQ, New York; WBOW, Terre Haute, Ind.; WBT, Charlotte, N. C.; WBZ, Boston, Mass.; WCAE, Pittsburgh, Pa.; WCAU, Philadelphia, Pa.; WCBZ, Zion, Ill.; WDMA, Culver, Ind.; WEAF, New York; WEAO, Columbus, Ohio; WEBR, Buffalo, N. Y.; WENR, Chicago, Ill.; WEVD, New York; Akron, Ohio; WFOX, Brooklyn, N. Y.; WLAC, Nashville, Tenn.; WLBL, Stevens, Wis.; WMSG, New York; WNBX, Springfield, Vt.; WOAI, San Antonio, Tex.; KPFP, Spokane, Wash.; KFRC, San Francisco, Calif.; KGFV, Kearney, Neb.; HHK, Port au Prince, Haiti; HRB, Tequicgalpa, Honduras; Canadian Wave, CFCN, Calgary, Alberta; CFRB, Majestic Corp., ChRC, Quebec, Que.; CHNS, Halifax, N. S.; CJBC, Toronto, Ont., only on Sunday; CKAC, Montreal; CKCI, Quebec; CKGW, Toronto; VECA, Western Broadcasting, Calgary.

FRANCYS CARVILLE.

1, Place des Vallées,  
Bois Colombes, France.

In our issue of November, 1932, we asked our readers to contribute letters giving the results of their DX experiments. This new department is to further efforts in this direction.

There has been an increasing interest of late in long distance reception, particularly in the broadcast field, and there seems to be a race at the present time between owners of broadcast sets and short wave sets to outdo each other in DX performance.

Many people probably do not realize that thousands of broadcast listeners are making records almost daily, and even broadcast reception from Australian stations received in the United States is not impossible today.

In this department, we will publish monthly letters from DX listeners relating to their experiences and all letters for publication must be sworn to by a Notary Public to make sure that our readers get only such data as are authentic, so far as this can be done.

We shall try to publish as many of the letters as we can; but it may be impossible to publish all of them.

We would be glad to have your comment on this new department.

WCAU, Philadelphia; WINS, New York; WOAL, San Antonio, Tex.; VONA, 500 watts, St. Johns, N. F.; WFBE, Cincinnati; WJBL, Decatur, Ill.; WNBO, Washington, Pa.; WORC, Worcester, Mass.; WFAS, White Plains, N. Y.; WGBB, Freeport, N. Y.; WGNV, 50 watts, Chester Township, N. Y.; WHBF, Rock Island, Ill.; WJBY, 100 watts, Gadsden, Ala.; WPRO, Providence, R. I.; WSEN, Columbus, Ohio; WCAE, Pittsburgh; WREN, Lawrence, Kans.; WFBM, Indianapolis; WNAC, Boston; KTFI, Twin Falls, Idaho; WXYZ, Detroit; KFOX, 1000 watts, Long Beach, Calif.; WAAM, Newark, N. J.; WLB, Minneapolis; WODA, Paterson, N. J.; KOIL, Council Bluffs, Iowa; WLBW, Erie, Pa.; WFBR, Baltimore; WCAM, Camden, N. J.; WCAP, Asbury Park, N. J.; WDDO, Chattanooga; WIBA, Madison, Wis.; WTNJ, Trenton, N. J.; KDYL, Salt Lake City; WEBC, Superior, Wis.; WJAS, Pittsburgh; WBBR, Brooklyn, N. Y.; WEVD, New York City; WHAZ, Troy, N. Y.; WIOD, Miami, Fla.; WEBR, Buffalo; WEXL, 50 watts, Royal Oak, Mich.; WNBH, New Bedford, Mass.; WOL, Washington, D. C.; WTRC, 50 watts, Elkhart, Ind.; WADC, Tallmadge, Ohio; WDRG, Hartford, Conn.; WSAL, Cincinnati; WTAQ, Eau Claire, Wis.; WSPD, Toledo, Ohio; KWK, St. Louis, Mo.; WBNX, and WCDA, New York; KGER, 1000 watts, Long Beach, Calif.; KGIR, 500 watts, Butte, Mont.; WFBL, Syracuse,



# READERS' DEPARTMENT

A department in which the reader may convey his thoughts to other readers. Included in this department are letters, kinks, short cuts, and experiments. Send in your ideas.

## THE CAR PLATE-TYPE ANTENNA

Editor, RADIO CRAFT:

I am a regular reader of RADIO CRAFT, and note, in checking through my back copies, an article on page 29, in the November, 1932, issue, regarding automobile radio installation. This article is under the heading of "A Convenient Car Antenna" (second paragraph), in which the author suggests the use of a plate, underneath the car, to be used instead of a direct ground to the frame of the car.

We have tried this antenna circuit with a model 96 Crosley Roamio on a late model Dodge 8 sedan, and wish to advise you and anyone else who is associated with radio service work on automobiles that the idea is well worth while. Before using this circuit we connected to the regular antenna of the car (factory installed) with the conventional ground to the frame. The results were not at all satisfactory due to the low sensitivity of the average sedan antenna. However, by disconnecting the ground from the antenna coil and bringing it direct to an insulated plate placed midway under the car frame, the pick-up and volume of the set were increased at least 100 per cent. It is now possible to get good daylight reception from several stations which could not possibly be heard before, this being a rather remote section for auto reception.

We do not hesitate to recommend this method to anyone who is having trouble in getting sufficient volume on an auto radio. They will be well repaid by the results.

STANLEY L. STEVENS,  
Auto-Radio Service Department,  
Fernand Seiler, Bloomsburg, Pa.

## REDUCING CAR-RADIO INTERFERENCE

FRANK N. MAYER

Did you know that oftentimes the ignition system of a car may be so "tuned" as to greatly reduce car-radio interference? Perhaps "de-tuned" would more aptly express the idea, which is to resonate the car's ignition system to a wavelength outside the range of the automotive radio receiver.

The following data concerning an "ignition tuner" for this purpose, supplements the writer's previous discussion concerning the electrolock cable; the story appeared in the February, 1933, issue of RADIO CRAFT, and is entitled, "Interference Elimination in Car-Radio Installations."

Before building the "tuner," try

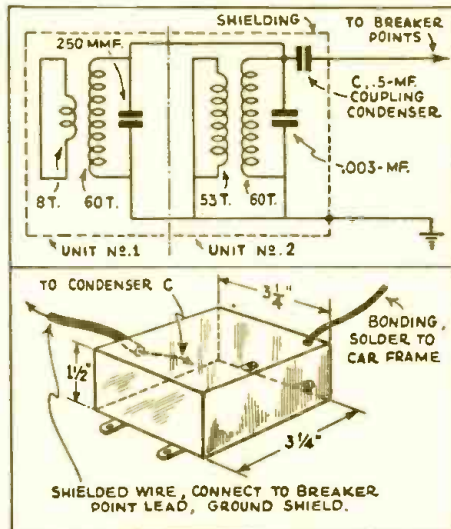

Fig. 1

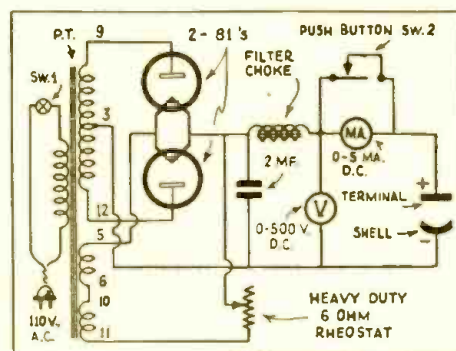

Fig. 2

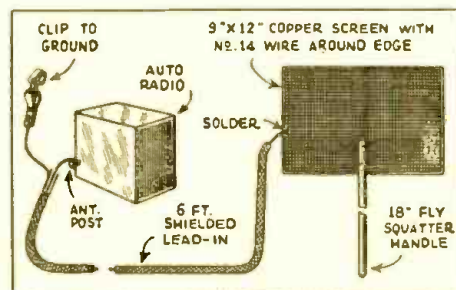

Fig. 3

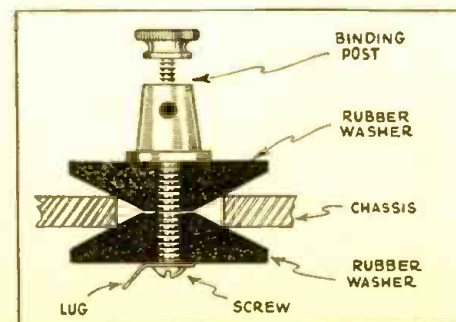

Fig. 4

some of the ordinary tricks, such as reversing and shielding the ignition coil leads, shielding the heavy, or "A" hot wire from the storage battery, "building up" the distributor contact arm, and also rebuilding the electrolock cable (as previously described). In case the car in question does not use an electrolock system, run a shielded wire to the breaker point housing.

The ignition tuner is made up of two respective units, Nos. 1 and 2 in Fig. 1, connected in parallel. The completed tuner is connected to the breaker point lead by a .5-mf. coupling condenser, C.

Unit No. 1 is composed of a basket-wound coil of 60 turns, 2 5/8 in. in diameter, with an 8-turn coil interwoven into the 60-turn coil and short-circuited upon itself. The 60-turn coil has a 250 mmf. fixed condenser connected in parallel with it. One end of the 60-turn coil and condenser combination goes to the .5-mf. coupling condenser, and the other end goes to ground.

Unit No. 2 is also made up of a 60-turn basket-wound coil, 2 5/8 in. in dia. with a 53 turn coil wound directly over it. A .003-mf. fixed condenser is connected across the 60 turn coil; one end of this coil is connected to the same .5-mf. coupling condenser as unit No. 1, and the other end of the coil and condenser combination is connected to ground. The 53 turn coil is short-circuited upon itself and connected to ground. (The frame of the car is to be used as ground.)

After the units have been correctly connected, tape the two coils together, with the .003-mf. and 250 mmf. fixed condensers placed inside the coils. Solder the .5-mf. condenser to the inside of the can and place the coils in there, also; the can details are shown in Fig. 1. Solder the two coil leads of units 1 and 2 to the condenser; the ground leads of the units may be soldered to the can. By drilling a small hole in the can, a shielded lead may be brought in, the shield connected to the can, and the wire connected to the blank side of the coupling condenser. This shielded lead is for connecting the tuner to the breaker points. After all connections have been made run the can full of sealing compound to complete the tuner.

Ground connections to the coils and shielding should be made by a piece of bonding soldered to the can in which

(Continued on page 750)



# for MEMBERS

## An Important Message to Radio Service Men

EVER SINCE the manufactured radio broadcast receiver became an accepted necessity in the household, the Radio Service Man has been an essential factor in the radio trade; and, as the complexity of electrical and mechanical design increases, a higher and higher standard of qualifications in the Service Man becomes necessary.

The need for a strong association of the technically qualified radio Service Men also becomes more pronounced as the industry progresses. This is the fundamental purpose of the OFFICIAL RADIO SERVICE MEN'S ASSOCIATION, which is not a money-making institution, or organized for profit; to unite, as a group, with common interests, all well qualified Radio Service Men; to make it readily possible for them to keep up with the demands of their profession; and above all to give them a recognized standing in their profession, and acknowledged as such by the entire radio industry.

Recently, at a meeting of the membership committee of the ASSOCIATION, a new group of members was started. Formerly, all applicants for membership were required to pass a rigid examination to prove their ability to cope with any servicing problem. However, there are a number of capable Service Men who either through lack of time or other causes cannot take the examination, and in order to permit these men to enjoy the advantages of membership, until such a time that they can pass the full membership examination, an *associate membership* was created.

In order to become an associate member, the applicant simply has to fill out a form listing his past experiences, type of test-instruments used, etc. He is then immediately accepted as an associate member and may obtain any of the essentials shown on this page. The essentials for the associate member differ only in the specification of *Associate Member* in place of *Member* as shown in the illustrations.

The Service Men's Essentials are sold only to members and associate members. Service Men are therefore urged to clip the coupon below and send it to the OFFICIAL RADIO SERVICE MEN'S ASSOCIATION, Inc.

Be sure to specify whether you desire the application for *full membership* or *associate member*.

### Application for Membership in ORSMA

Executive Secretary, ORSMA  
98 Park Place, New York, N. Y.

Kindly send an application blank for

- Full Membership  
 Associate Membership

Name \_\_\_\_\_

Street or Box \_\_\_\_\_

City \_\_\_\_\_ State \_\_\_\_\_



No. 14—50c each  
(Plus 10c for postage)

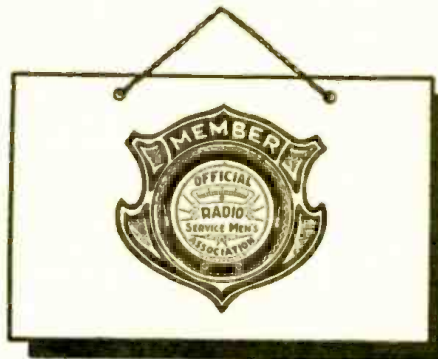

No. 11—50c set of three cards



No. 12—\$3.00 set of 25 cards

 **These DISPLAY SIGNS** are printed in attractive colors and they are certain to help Service Men in their business if they are placed in local stores where they can be seen and read.

 <b>RADIO SERVICE SHOP</b> 2121 Park Ave., N.W. Washington, D. C. West 1294	
Name _____	Address _____
Phone _____	City _____
State _____	Zip _____
Business _____	Home _____
Education _____	Other _____
Service _____	Per Hour _____
Time _____	Total _____
Sent by _____	
<small>This set may operate in any radio connection, and where charges are OK.</small>	
<small>Signature of member</small>	
<small>For your protection, sign also "OFFICIAL" on other side for true membership card only.</small>	

No. 3—60c per pad of 50  
\$3.00 per ten pads, each of 50

 <b>RALPH C. REEDER</b> 1131 So. Paxson Street Philadelphia, Pa.	
SET SERVICED	TUBES CHECKED
SET SHOULD BE INSPECTED:	
_____	
<small>WHEN IN NEED OF SERVICE MAKE CALL</small>	

No. 4—50c per 100  
\$3.00 per 1000



No. 8—40c each

### THE RADIO SERVICE MEN'S Assortment Package

In order to facilitate new members in getting started, we have made up an assortment of essential materials, as follows:

- 100 No. 1 Letterheads
  - 100 No. 2 Envelopes
  - 1 pad (50) No. 3 Record Cards
  - 100 No. 4 Inspection Labels
  - 1 No. 5 Gold Filled ORSMA Lapel Button
- Imprinted with your name, address, city and telephone number  
Price **\$3.00** Prepaid  
per set



# Radio Service Men's Essentials of the ORSMA



No. 9—75c each, large size  
9A—60c each, small size



No. 10—75c each, large size  
10A—60c each, small size



No. 5—50c each

## SERVICE MEN'S ESSENTIALS

**T**HE OFFICIAL RADIO SERVICE MEN'S ASSOCIATION has made arrangements to supply a number of "Service Men's essentials" for the use of its members and associate members. Only members and associate members can buy these items; they are not sold to others.

These essentials are priced at cost, plus a small additional fee which is the only source of income that the Association has. No one obtains any profit or benefit, except the Association itself. Whatever profit accrues, is reinvested for the furtherance and enlargement of the Association.

By using the letterheads, billheads, etc., you present the business-like appearance to your customers, so essential to successful servicing. In addition, the Association has made arrangements with most of the prominent manufacturers to allow special discounts to members, providing ORSMA letterheads are used when ordering.

### No. 1 ORSMA LETTERHEADS

These letterheads, shown on the right, are furnished with your name, address and telephone number, printed on excellent paper. They are sold in lots of 100 or multiples thereof, with a distinct saving for single orders of 1,000 or more. You would have to pay many times more if you ordered small lots from your local printer. Per 100, 60c; per 1000, \$3.00.

### No. 2 ORSMA ENVELOPES

These are furnished to match the letterheads, printed with your name and address, and seal of the Association. They go hand-in-hand with the letterheads and are usually ordered in the same quantity. Per 100, 60c; per 1000, \$3.00.

### No. 3 ORSMA SERVICE RECORD CARDS

They serve a double purpose: whenever you complete a job you fill out the report-bill and hand it to the customer; this is the "psychological moment" to collect. By the use of carbon paper a permanent record is kept which is a valuable asset to your business. They are furnished with your name, address and telephone number. Per pad of 50, 60c; per 10 pads, each of 50, \$3.00.

### No. 4 ORSMA INSPECTION LABELS

The label is to be filled in with the proper dates, and pasted inside the set or cabinet where the customer will see it. It is a continuous reminder to him that, when service is needed, he can call you again. The advantage is apparent. Per 100, 50c; per 1000, \$3.00.

### No. 5 ORSMA LAPEL BUTTON

At the suggestion of many members a handsome lapel button bearing the name and emblem of the Association has been designed. It signifies to your fellow members that you belong to the same Association;—and in addition it gives your customers a better appreciation of the professional nature of your work. 50c each.

### No. 6 ORSMA BUSINESS CARDS

These are furnished on a fine grade of paper in two colors with a blotter back. Thus they present an added incentive to your customers to keep them in a prominent place, where they will do the most good. They are printed with your name, address, and telephone and bear the official seal of the Association. Per 100, 75c; per 1000, \$4.00.

### No. 7 ORSMA EMBOSSED STICKERS

Ideal for use in sealing packages, envelopes, etc., or for use on post cards. They give your letters or cards a professional aspect. They are sold in lots of 100 or more. Per 100, 85c; per 1000, \$6.00.

### No. 8 ORSMA RUBBER STAMP

A handy addition to any member's equipment. The first line of the stamp bears your name and the second reads—Member Official Radio Service Men's Ass'n. This stamp has many uses in the everyday life of a Service Man. 40c each.

### Nos. 9 & 10 ORSMA EMBLEM CUTS

These cuts for printing, advertising, etc., are furnished in two styles and sizes. They may be used for newspaper or telephone-book advertisements or for printing of any kind. Large size, 1 1/4 x 1 1/4 in., 75c each; small size, 3/4 x 3/4 in., 60c each.

### No. 11 ORSMA MEMBERSHIP SIGN

A set of three of these signs, printed on heavy cards, and having holes punched in order to hang in your office or store, and are sold to members and associate members. They are large enough so that they are quite prominent and the two tone effect makes a very attractive appearance. Set of three, 50c.

### No. 12 ORSMA ADVERTISING DISPLAY SIGN

A two color sign printed in large letters with your name, address and telephone, with the seal of the Association. This sign is sold in quantities of 25 or more and is ideal for hanging in stores, offices, etc., for advertising purposes. Set of 25 cards, \$3.00.

### No. 13 RADIO SERVICE MEN'S ASSORTMENT PACKAGE

This includes one gold filled lapel button, 100 letterheads, 100 envelopes, 50 service record cards, and 100 labels printed with your name and address as described above. The whole assortment costs only—\$3.00—a worth-while saving. Complete, \$3.00.

### No. 14 ORSMA MEMBER CERTIFICATE

A handsome diploma-like certificate engraved on stiff vellum-bound. The certificate is personally signed by the President and Executive Secretary and the corporation stamp of the Association is impressed on a red seal attached to it. Your name, certificate number and date of registration are lettered by hand and the Certificate is mailed in a cardboard tube to insure safe delivery. Each 50c, plus 10c for postage.

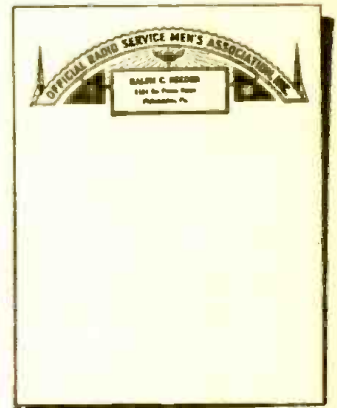

No. 1—60c per 100  
\$3.00 per 1000



No. 2—60c per 100  
\$3.00 per 1000



No. 6—80c per 100  
\$4.00 per 1000



No. 7—85c per 100  
\$6.00 per 1000

OFFICIAL RADIO SERVICE MEN'S ASSOCIATION  
98RC Park Place, New York, N. Y.

Please send me the following RADIO SERVICE MEN'S ESSENTIALS which I have selected from this advertisement. My remittance for \$..... is enclosed. Send remittance in form of check or money order. Register letter if it contains, cash, currency or unused U. S. Postage Stamps.

Name ..... ORSMA No. .... Address ..... City and State .....



# RADIO-CRAFT'S INFORMATION BUREAU

SPECIAL NOTICE TO CORRESPONDENTS: Ask as many questions as you like, but please observe these rules:

Furnish sufficient information, and draw a careful diagram when needed, to explain your meaning; use only one side of the paper. List each question. Those questions which are found to represent the greatest general interest will be published here, to the extent that space permits. At least five weeks must elapse between the receipt of a question

and the appearance of its answer here. Replies, magazines, etc., cannot be sent C. O. D. Inquiries can be answered by mail only when accompanied by 25 cents (stamps) for each separate question. Other inquiries should be marked "For Publication," to avoid misunderstanding.

## SERVICE BOOKS—WINDSOR MODEL 70 SET

(198) Joseph Baron, 545 Quincy Street, Brooklyn, N. Y.

(Q.1) As a Service Man who is breaking into the radio game, I would appreciate any kind of help you can give me by letting me know how I should go about adjusting the trimming condensers of a set with an oscillator. As I happen to be one of those who sleep and eat radio, I would be very thankful for any help you can give me. Do you have a book on how to neutralize and balance radio sets? I would like to purchase same.

(A.1) We publish a series of ten books designed for men in your class. These 64-page, board-covered books carry the following titles:

Radio Set Analyzers and How to Use Them; Modern Vacuum Tubes; The Superheterodyne Book; Modern Radio Hookups; How to Become a Radio Service Man; Bringing Electric Sets Up to Date; Radio Kinks and Wrinkles; Radio Questions and Answers; Automobile Radio and Servicing; and Home Recording. We also recommend to you the following two publications of Press Guild, Inc., New York City: Elementary Mathematics for the Technician and Craftsman, and Fundamental Principles of Radio.

Most of these books contain information pertaining to your questions but since the answer varies with the particular type of receiver and its individual manufacturer, it is not possible to give specific information. It is recommended that the RADIO-CRAFT Data Sheets be consulted for detailed procedure concerning the individual set models.

(Q.2) What is the schematic circuit of the Windsor Model 70 receiver? This set is made by National Transformer & Radio Mfg. Co.

(A.2) The diagram of the Model 70 receiver is shown in Fig. Q.198A. We call your attention to the detailed comments on this receiver which appeared in the May, 1933, issue of Radio-Craft in the article entitled, "Trouble in a Windsor 70 S. G. Set," on page 665.

## INTERMITTENT OPERATION—OHMITE "DETER-OHM"

(199) Paul V. Brown, South Main Street, Oberlin, Ohio.

(Q.1) I am a student and a Service Man. Being in the business for four years I've hit upon a lot of trouble—your magazine kinks quite often help, but in one case, I have as yet to find a solution.

I have a Radiola 46. The tubes being new,

the set starts out to work like a new one. But, after a while, it "pops" and goes off dead. If one waits a minute, or sometimes two or three minutes, it will come back; also, snapping an electric light switch will make it go on or off. At first I thought of a broken aerial, but that was checked. The snapping of the electric switch raises a new question. Could you help me in getting a solution to the trouble.

(A.1) The trouble you describe is not an unusual one, but that doesn't make it easier for you to locate the cause and eliminate the trouble. The first thing to do is to try to localize the fault to some portion of the chassis by connecting milliammeters in the tube plate circuits to determine whether the current flow through these elements in the R. F., detector or A. F. stages is interrupted. If there does not appear to be any disturbance in the current flow to any of the tube elements, then perhaps an intermittent short circuit is occurring in an R. F. circuit. It is possible that by the substitution method the fault may be localized to one section. It then remains to closely examine, or else apply other tests to, this portion of the chassis.

If a minute inspection, and a mechanical test by means of a prod, of every wire and unit in this section of the chassis does not

(Continued on page 755)

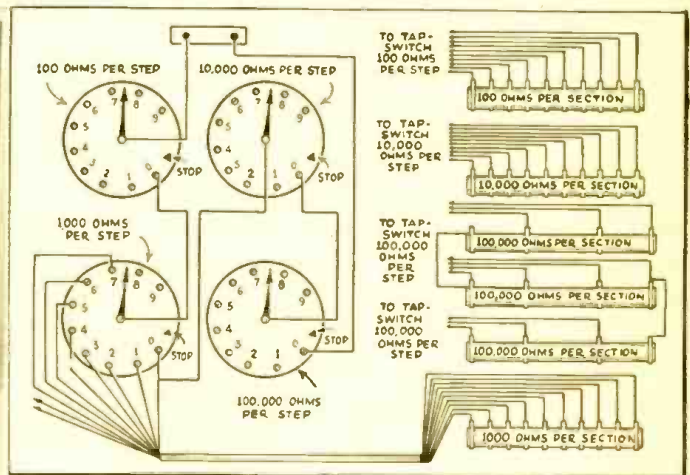
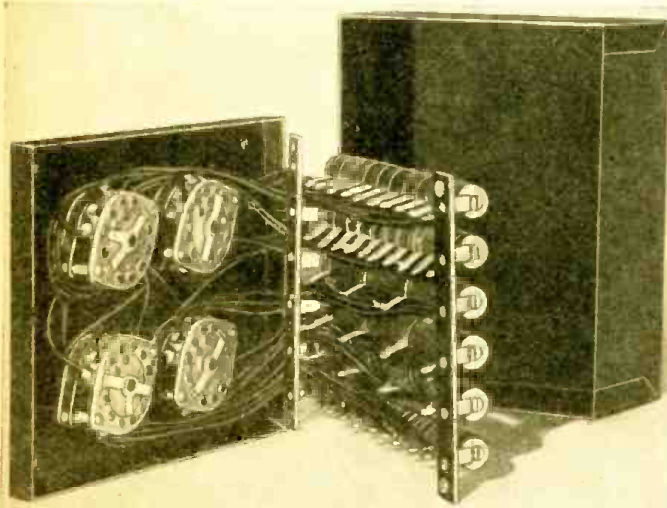

Figs. Q.199A and 199B

Above: Schematic circuit of the decade box; and left, a photograph of same.

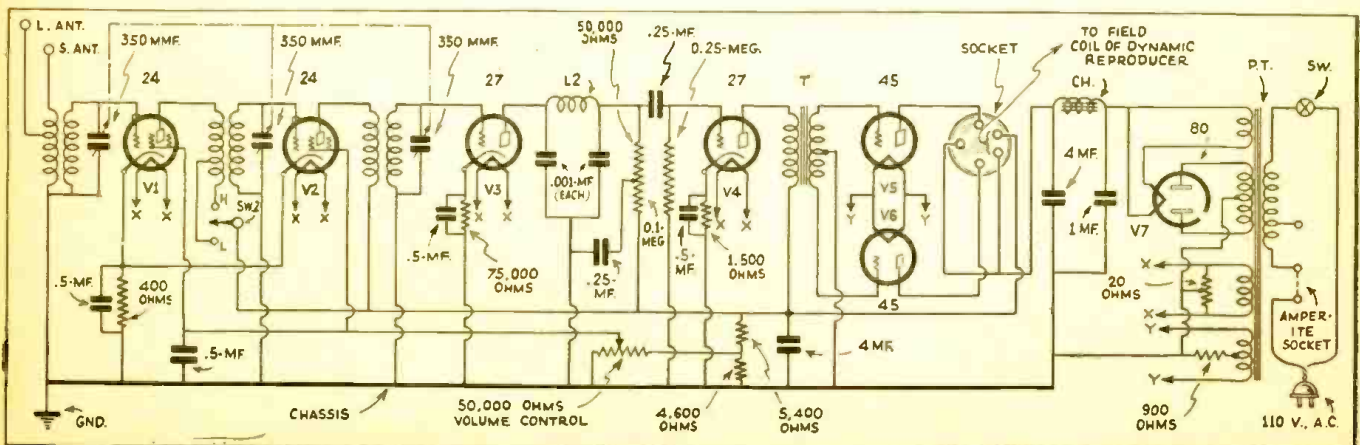

Fig. Q.198A

Schematic circuit of the Windsor model 70 receiver. The values of all parts are shown.









QUALITY APPARATUS FOR

### Short Waves

#### GEN-WIN SHORT WAVE COIL KIT

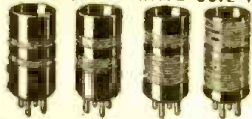

These coils are considered the finest made. Each coil is precision wound on a different colored bakelite form for quick identification of wave lengths. Used and highly recommended by all short wave experts. Range (16 to 22.5) meters, using a .00014 or .00015 mfd. condenser. Recommended for the following sets: "The Globe Trotter," "The Overseas," "The Doerle 12,500 Mils Two Tube Receiver and Doerle Three Tube Signal Gripper," "The Megadyne," "4 Coil Enamel Wire Kit \$1.50" "4 Coil Litz Wire \$2.25" "Broadcast Coil. (200 to 550 meters) .55c"

#### POLICE AND SHORT WAVE ADAPTER

Convert your broadcast set into a shortwave set tuning from 80 to 200 meters.

Get exciting police alarms from stations thousands of miles away. Airplane communications while planes are in flight. Amateur phone and international code communications. The biggest thrill and fun for a little money.

Installed in a jiffy. Plugs directly into detector tube socket. Specify the detector tube in your set, or if uncertain as to detector tube, advise make and model number of set when ordering.

No. 200—for '27, '37 \$1.39  
and '56 Det. tube  
No. 201—for '24, '35, and '36 Det. \$1.39 tube

#### ALL-WAVE COIL KIT

Range 25 to 550 Meters

Comprises a piece of piano wound tuner and R. F. coil, with tapping section, which permits you to enjoy both SHORT WAVE and BROADCAST PRO. GRAMS. If you own an Ambassador or any other three circuit tuner receiver, you can easily convert the set into an all wave receiver, by replacing the coils, with these new GEN-WIN ALL-WAVE coils. Coils may be had for use with either .00035 or .0005 Mfd. condenser. Specify which when ordering. Wiring diagram included free with coils. Separately 10c.

All Wave Tuner (as illustrated) 90c  
All Wave R. F. Coil 75c



Send remittance in check or money order. Resistor value if it contains currency.

**GENERAL WINDING COMPANY**  
214A FULTON ST. NEW YORK, N. Y.

if the trouble is here or here



### — Replace with CENTRALAB Volume Controls & Fixed Resistors

The Centralab Volume Control Guide gives you all the latest dope on replacements.

Jobbers everywhere carry complete stocks.

... Centralab Units have set the standard by which all others are judged.

Send for the new 50c Volume Control Guide... it is yours for two 3c stamps.

# Centralab

CENTRAL RADIO LABORATORIES  
930 E. Keefe Ave. Dept. C Milwaukee, Wis.

## READERS' DEPARTMENT

(Continued from page 745)

the units are sealed. This bonding may then be connected to the car frame after the tuner is mounted in the car.

This device gave its best results on Chevrolet and Ford cars. Some slight changes may be required to secure correct results because of changes in the capacity, inductance, and resistance of different car ignition circuits.

### TESTING ELECTROLYTIC CONDENSERS

HENRY T. PAISTE, Jr.\*

Electrolytic condensers can be tested by measuring the leakage current when high voltage, direct current is applied to the terminals. The higher the leakage current, the more likely is the condenser to break down after a period of operation.

A convenient test circuit is illustrated in Fig. 2. A power transformer, such as used in the Philco model 111 receiver, with the 24 and 80 filament windings connected in series supplies all voltages for the type 81 tubes. Reference numbers in the diagram are for connections to the terminals illustrated in the service bulletin on the model 111 set. If the 81 filament voltage is less than five volts, connect 6 and 11 together instead of 6 and 10.

A heavy duty, 6-ohm rheostat is connected in the filament circuit to control the D. C. output voltage. The control knob must be well insulated because of the high potential. The switch 6, used as a protection for the milliammeter is a specially constructed push-button type which closes the circuit at all times except when the button is pressed. This can be made by attaching a strip of phosphor bronze or other spring material to a piece of bakelite in such a manner that the spring will contact a terminal on the bakelite except when pushed away by the button.

The positive terminal for connecting the electrolytic condenser should be a rubber insulated battery clip. The negative terminal can be a metal plate on which the condenser will be placed for test. This plate must also be protected because of the high voltage.

Adjust the rheostat until the D. C. output voltage with the condenser in the circuit is exactly 430 volts. After one minute, re-adjust the rheostat until the output voltage is 400 volts. Now read the current on the milliammeter. New condensers will average 0.2-ma. per micro-farad.

Electrolytic condensers whose leakage current is in excess of one milliamper per microfarad should be replaced.

In some cases the condenser will not form properly in one minute, and will show an excessive leakage current. Such condensers should remain on charge at 430 volts for ten minutes before the leakage current reading is taken at 400 volts.

A shorted or partially shorted condenser will be indicated by a low voltmeter reading. Do not attempt to take a milliammeter reading with such a condenser in the circuit; the current is excessive and is likely to burn out the meter.

\*Service Dept., Philco Radio & Telev. Corp.

### AN AUTO-NOISE PICK-UP TOOL

F. E. PATTERSON

To find that noise maker in the auto, take about 6 feet of shielded lead-in wire and solder it to a piece of copper screen about 9 by 12 ins.; put a No. 14 wire around the edge to stiffen the screen, tack on a short wood handle and it's ready for business. The idea is illustrated in Fig. 3. This is a useful auto-radio tool.

### BINDING-POST INSULATION

LOUIS RALUS

Here is a "wrinkle" that may prove useful. Often, in building sets using metal chassis, it is desired to mount binding posts on the chassis for antenna leads, speaker output, power supply connections, etc.

To readily do this, we use this system: procure from the "dime store" a supply of plumber's washers. They sell 10 for 5c. They are about 1/2-in. in diameter and are somewhat cone-shaped, as shown in Fig. 4. Drill a hole in the chassis slightly smaller than the outside diameter of the rubber washer and place one washer on each side of the hole, as shown. A washer may be required under the binding post to prevent it pulling through the chassis.

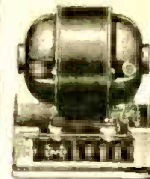

## CARTER Genemotor Power Plant

Makes auto radio sets all-electric—more power—

greater volume—better tone. Consumes less than 2 Amps.—delivers 180 Volts at 30 M.A. or more—No parts to replace—or adjust—no oiling—no tubes—no vibrators or relays—guaranteed one year—also supplied for 32 volt farm light equipment—high voltage type for sound trucks and class "B" amplifier equipment.

Write for Circular

### CARTER GENEMOTOR CORP.

365 W. Superior St. Chicago, Illinois

## RADIO OPERATING RADIO SERVICING



Prepare for the new Government Radio Operating license examinations; Radio Operator, Marine and Broadcasting. Also radio Amateur Telegraph and Telephone. Resident courses. Write for booklet.

### "Opportunities in Radio"

### WEST SIDE Y M C A TRADE & TECHNICAL SCHOOLS

7 West 63rd Street New York City

## AUTO RADIOS

The season for auto-radios is here. Live-wire dealers and servicemen can make big money this summer installing better auto-radio sets at prices that are sensationally low.

The TRUMAN Auto-Radio is all-electric, employs six tubes and has two stages of audio. The set is extremely compact and measures only 6x6x12 inches. Crackle finished case enhances set greatly. Only three wires to connect and set is ready to operate. Traveling light and vernier dial makes tuning simple and accurate.

Dealers and servicemen write today for the astounding big discounts. Your chance to make money in a short season.

**TRUMAN RADIO SHOP**  
7443 Stewart Avenue  
Chicago, Illinois

We take pride in mentioning that we are "Builders of high class Midget Radios."

## PERSONAL

Need an extra wad of rent or gasoline money? Improve the sets you service. Plug Amperites the way the smart service boys do. Reuben Gordon, 2504 Bronx Pk. E., New York, averages \$90 per month on Amperites alone. Amperite Corporation, 561 B'way, N. Y.

### RADIO SERVICE MEN

Be sure to read the announcement on Page 754 of this issue, which tells about the new ORSMA BULLETIN. It is the most up-to-the-minute news tabloid for all radio Service Men.



# Earn Big Money

REPLACE BURNT-OUT and DEFECTIVE BALLASTS



MILLIONS of Sets including MAJESTIC and other standard lines need ballast Replacement NOW.

## JOBBER AND SERVICE ORGANIZATIONS—

Send for our plan outlining Ballast Replacement Market and Money Making Plan. Also Volume Control Replacement Data Book.

CLAROSTAT MANUFACTURING CO., Inc.  
285 N. 6th St. Brooklyn, N.Y.

## Auto Aerials

AXLE TO AXLE TYPE

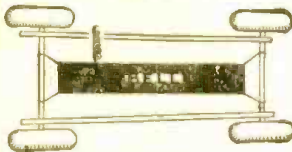

Size 36"x4".....\$1.00 Size 54"x6".....\$1.50  
Size 54"x4".....\$1.25 Size 54"x8".....\$1.75

### RUNNING BOARD TYPES

Size 36"x8".....\$2.00

Jobbers Write for Proposition

BELL RADIO SALES CO.

936 Westchester Ave. Bronx, N. Y.

## USE OHIOHM SPARK SUPPRESSOR SETS

for eliminating Ignition Interference on Automobile Radios

For 4, 6 and 8 cylinder cars. Furnished complete with condenser and necessary spark suppressors. Lasts the life of the car. Special non-shorting, and temperature and vibration resisting features. Cash in on this growing market.

THE OHIO CARBON CO.  
Cleveland, Ohio

## FORDSON'S

NEW LOW COST SUPER SIX-TUBE

Goldentone TRADE-MARK SUPERHETERODYNE

\$9.95

SIX-TUBE CHASSIS AND DYNAMIC SPEAKER WITH AUTOMATIC VOLUME CONTROL Using the new duplex diode triode type 55 tube WITH CLASS A POWER PENTODE Using the new seven prong type 59 tubes Send for FREE Circular



Fordson Radio Mfg. Corporation  
11700 Livernois Avenue,  
Detroit, Michigan

Send me FREE circular giving complete details and prices on the GOLDENTONE radio.

Name.....  
Address.....  
City..... State.....

## A JUNK-BOX GANG CONDENSER

By W. S. GILFOIL

The old Radiola superheterodynes using type 99 tubes contained a pair of 41 plate, 0.001-mf. condensers. As the cross bars holding the plates in place are made of solder, or some low-melting-point alloy, it is a simple matter to make a two-gang condenser from one of these units. Two of these condensers may be connected by a short piece of copper tubing and two screws to make a four-gang condenser. One of the original drum dials may be used if desired, although a better looking dial may be purchased.

Let us assume that you want a 0.00035-mf. unit. Since the plate area and spacing will remain the same, the formula

$$n-1 = \frac{.001}{.00035}$$

$$41-1 = .001$$

tells us that n, the number of plates in each unit of our finished instrument, must be 15. We will then leave 14 plates in the rotor and 16 in the stator, removing the center plates in each instance, leaving room for a shield.

Three soldered bars hold the stator plates in position. To each of these, solder two machine screws, one on each side of the portion to be removed. Drill bakelite strips to fit these screws, so that the portions will be accurately spaced when the solder is removed.

Take the rotor out and melt the solder from the three center plates in the stator, twisting the plates out with a pair of long-nose pliers. If you try to take out all five at once you may ruin the whole job. Your stator will now be in two sections so you can take the other plate from each half without danger of removing too much solder. Fasten the two halves together with the three bakelite strips and proceed to the rotor.

Melt the solder at the free ends of the six center plates (starting at the center as before) and twisting out with the pliers. They will pull out of the axis. This leaves you a common rotor with two sections of seven blades each. Scrape out any loose solder from between the blades of rotor or stator with a knife, and assemble. If necessary, loosen the screws holding the bakelite strips and adjust the clearance. If the screws were placed vertically and the proper size drill used on the bakelite this will not be necessary. Purchase or make a pair of trimmers and attach in a convenient plate. Make a shield of sheet metal.

For a 0.00015-mf. instrument you would leave 4 plates in each stator and 3 in each rotor. By using a little ingenuity, you can make a 3 gang condenser of this capacity, if desired, from a single 41 plate condenser.

## SMELLING SMOKE

Editor, RADIO-CRAFT:

It was suggested some time ago by one writer that the 27 tube could be substituted in the Sparton receivers for the 484. I did not believe it would work, but I tried it. The voltage problem is easy as the 27's have a higher drain and the voltage will usually fall a little below 2½ volts, so no change is required if all 6 tubes are changed to 27, but there is a loss of volume. This can easily be seen by noting the amplification factor of the two tubes. However, the power tubes may be easily changed by wiring the power sockets in series, putting in a 750- to 800-ohm resistor to change the grid bias. This may be connected at the center tap of the hum potentiometer and disconnecting the one at the center tap of the winding.

At a small expense a new transformer can be installed and then the new 56 tube can be used in place of the 484 and the volume will be just as good as with the 484; in fact, the amplification factor is a little greater and the 45 tubes can be used in place of the 83's in the usual manner; the grid bias, however, must be proper. No change in grid bias is necessary for the 56's. The difference in cost of one set of tubes will almost pay for the transformer.

We got quite a laugh out of the Jenkins foot board switch; I suppose that he had been phoning the power plant to shut off the power before he discovered this short cut. Well, if the sets he repairs do not have a switch, or he is unable to pull the plug, his idea would be quite a help. Personally, I like the smell of smoke from a radio. It is much easier to collect a reasonable fee for repairs if customers smell smoke!

IRA N. FAUROT,  
Smith Center, Kans.



# Put No. 711 on Your Payroll!

TESTER No. 711 Only \$22.50  
Net to Dealers (List \$37.50)

"A Remarkable Instrument At a Remarkable Price!"

NO MATTER how many testers you now have, you can afford to put No. 711 on your payroll because it brings in more money with less effort... enables you to do a quicker, better testing job!

### New, Improved Features

Readrite Tester No. 711 is similar to the famous Readrite No. 710, but better. It is equipped with the new Triplet D'Arsonval Voltmeter, having 1000 ohms per volt resistance. The reading is 0-15-60-300-600 volts, which covers a complete range for testing control grid, screen grid, cathode and plate voltages.

It is equipped with a practical selector switch for checking all parts of the tube circuit by connecting to the set sockets. It is so designed that selection can be quickly and accurately made for testing voltages of plate, grid, cathode, suppressor grid and screen grid.

Both A.C. and D.C. filament voltages are accurately measured. Contains new wiring and socket for taking care of new small and large 7-prong tubes. It is equipped with a small diameter plug-adaptor for testing in new sockets. Try this amazing tester one day and you'll wonder how you ever got along without it.

### Your Jobber Can Supply You

Your jobber can supply you at the dealer's net price of \$22.50. Send coupon for more details.

READRITE METER WORKS  
56 College Ave. Bluffton, Ohio

## MAIL COUPON NOW

Readrite Meter Works,  
56 College Ave., Bluffton, Ohio

Gentlemen:

Please send me information about Readrite No. 711 Tester. Also catalog of other servicing instruments.

Name.....

Street Address.....

City..... State.....



# RCA INSTITUTES

Recognized Standard in Radio Instruction Since 1909

## Technical Training Courses in Radio and Associated Electronic Arts

Practical Radio Engineering  
Sound Engineering  
Broadcast Transmission  
Radio Servicing  
Commercial Radio Operating

**Resident Schools at New York and Chicago**  
EXTENSION COURSES for HOME STUDY under new "no obligation" plan, with privilege upon graduation of 2 weeks' intensive practical training without charge at either Resident School.

Mail Coupon for Illustrated Catalog

**RCA INSTITUTES, INC.,**  
Dept. RT-6  
75 Varick Street, New York, N. Y.  
1154 Merchandise Mart, Chicago, Ill.

Please send with no obligation to me:  
( ) Illustrated catalog and information about resident school courses.  
( ) Information about extension courses for study at home, together with illustrated catalog.

Name \_\_\_\_\_ Age \_\_\_\_\_  
Address \_\_\_\_\_  
City \_\_\_\_\_ State \_\_\_\_\_

**RADOLEK RADIO**  
**Profit Guide**  
**RADOLEK CHICAGO**

Best Selection  
Lowest Prices  
Quickest Service

Better get on our list - It Will Pay You - Send Coupon

RADOLEK CO., 126 Canal Station, Chicago  
Gentlemen: Please send me the Profit Guide.  
I am a Dealer  Serviceman   
I operate from Shop or Store  from Home   
I own the following Test Equipment \_\_\_\_\_

My training and experience is \_\_\_\_\_

Name \_\_\_\_\_  
Address \_\_\_\_\_

**RADOLEK**

## New Short Wave D-X Sensational Converter

A simple amazing D-X device is being offered on trial to users by J. H. Miller, 512 Kirkwood Building, Kansas City Mo., with which any radio set can be converted into short wave frequency, bringing in police, amateur and air plane stations at full loud speaker volume. Enjoy thrills of short wave reception. Easily attached without charge by anyone. Mr. Miller wants local agents and is willing to send you a no-cost sample. Write him today.

## DUPLEX CALL SYSTEM

(Continued from page 719)

is the manner in which the cumbersome and sometimes unreliable microphone battery is eliminated: part of the D.C. filament current is forced to pass through the microphone buttons, and the other part through the biasing resistor, R1. This resistor is of such value as to supply the microphone with the proper amount of exciting current at all times. This circuit automatically prevents any excessive microphone currents and its resulting "packing" of the carbon granules. It further removes the current from the microphone every time the amplifier is shut off, thereby increasing the life of the microphone.

The output of the 30 tube is resistance coupled into the 47 audio stage producing faithful reproduction of the input signals. The 47 tube is connected to an output transformer T2, which has a secondary winding to accommodate a 15 ohm load. This output permits the use of a 500- to 5,000-foot extension line of No. 14 wire with a resulting loss of less than approximately 10% of the total output, which is negligible for all practical purposes. The other end of this transmission line may be connected directly to any D.C. A.C., or permanent-magnet dynamic speaker equipped with a 15-ohm voice coil, or to any magnetic speaker equipped with a correspondingly matched input transformer, such as T3. Two potentiometers, R7 and R8, are placed ahead of each speaker, the potentiometer R8 serving as volume control when the switch S1 is in the "on" position only when two-way communication is being carried on. The potentiometer R7 is located at the rear of the chassis and is set at some position below any possible microphone feedback condition. However, these two potentiometers are shunted out of the circuit by the switch S1 the moment the amplifier is put in the "off" position, thereby permitting maximum energy transfer from one amplifier to its corresponding speaker. In other words, each speaker is delivering its full output only until the amplifier located in the same cabinet is thrown "on" for two-way conversation. Therefore, the moment switch S1 is thrown on, the speaker output is automatically reduced to a sound level similar to that of a normal voice, for there is no need to then listen to the full 3 watts output. This action makes the whole system fool-proof, as it is necessary to turn the amplifier on in order to reduce the speaker output, and vice-versa. This procedure avoids the possibility of having the output turned down while the other party at another station, is trying to talk through a loudspeaker which has its volume control turned all the way down. A ruby light bezel indicates whether an amplifier is turned on.

### List of Parts (for One Station)

- One Coast-to-Coast cabinet, 15x8½x7 in. deep;
- One Coast-to-Coast chassis, and three cans, type CH637;
- One Best magnetic speaker, Model Sp637, (SP1);
- One Sound Engineering double-button microphone, type C1099, M1;
- One Remington power transformer, type PT637;
- One Remington filter choke, 30 hy., 500 ohms, type 6167, CH1;
- One Remington filter choke, 30 hy., 400 ohms, type Ch637, CH2;
- One Remington double-button microphone transformer, type 6164, T1;
- Two Remington output transformers, type T637, T2, T3;
- One Coast-to-Coast resistor, 50 ohms, 5 watts, type 1748, R1;
- One Lynch resistor, 500,000 ohms, 1 watt, R2;
- Two Lynch resistors, 250,000 ohms, 1 watt, R3, R6;
- One Lynch resistor, 50,000 ohms, 1 watt, R4;
- Two Coast-to-Coast 5,000-ohms resistors, 5 watts, type 4601, R5A, R5B;
- Two Carter 40-ohm potentiometers, R7, R8;
- One Elkon 10 mf., 35 volt, electrolytic condenser, type 5224, C1;
- One Solar tubular condenser, .02-mf., 400 volt, type 6713A, C2;
- One Elkon three-section, 8 mf., 500-volt electrolytic condenser, type 5332A, C3, C4, C5;
- One Solar 10 mf., 35 volt, electrolytic condenser, C6;
- One H & H D. P. D. T. toggle switch, S1;
- One Yaxley pilot bulb and bezel, P;
- Sockets, binding posts, extension cable, and miscellaneous hardware.

# VAN

announces

## SHUNTS-DIALS RESISTORS

for the Beede 1 mil. meter  
COMPACTNESS — STABILITY  
QUALITY

ORDER THROUGH YOUR DEALERS

If they cannot supply, send for folder.

D. L. VAN LEUVEN—Laboratory  
410 East 15th St. New York City

### CAN YOU READ THIS?

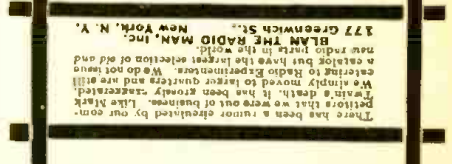

## SERVICEMEN and DEALERS

Radio Service Parts in Stock for all Models of—

### General Motors and Dayfan Radios

Specialists in G. M. Speaker repairing. Send us defective parts that you cannot replace. We will duplicate them for less money than elsewhere.

Send for our latest catalog FREE

General Mfrs. Radio Service, 255 7th Ave., New York City

Sensitivity **SHURE** Tone Quality  
**MICROPHONES**  
TRADE MARK REGISTERED  
**SHURE BROTHERS COMPANY**  
Manufacturers—Engineers  
S. N. SHURE, Pres.  
337 WEST MADISON ST. CHICAGO, ILLINOIS

## DEALERS & SERVICEMEN

**FREE!** Your copy of our Latest Bargain Bulletin NOW READY.

Send for it today.

AIREX, 80 Cortlandt St., New York City

# MAILING LISTS

Pave the way to more sales with actual names and addresses of Live prospects.

Get them from the original compilers of basic list information—up to date—accurate—guaranteed.

Tell us about your business. We'll help you find the prospects. No obligation for consultation service.



60 page Reference Book and Mailing LIST CATALOG

Gives counts and prices on 8,000 lines of business. Shows you how to get special lists by territories and line of business. Auto lists of all kinds. Shows you how to use the mails to sell your products and services. Write today.

## R. L. POLK & CO.

Polk Bldg.—Detroit, Mich.

Branches in Principal Cities

World's Largest City Directory Publishers

Mailing List Compilers. Business Statistics. Producers of Direct Mail Advertising.



# NOW READY

## The RADIO-CRAFT INDEX

It contains a thorough, alphabetical and topical arrangement of EVERY article and subject which has been published in all the issues of RADIO-CRAFT from July, 1929 to June, 1932

Radio Men have conclusively proved to us the need and practicability for a book which has included in it, a comprehensive and complete listing of every article which has thus far been published in RADIO-CRAFT. A book which has each topic so sub-divided and cross-indexed that a mere glance at a subject will give you any number of classifications and uses of it. For example, if you look at tubes, you find under this topic, various sub-titles, general, power, transmitting, photo-cells, testing of tubes, thyratrons, etc. Every article or notice in the book has been considered so deeply important that when you refer to a certain classification, listed below the main topic, you will find perhaps a dozen or more articles treating the subject from different angles. The author in each case is given—the exact issue in which the article appeared, and on what page it is to be found. So accurately compiled, by C. W. Palmer, one of radio's foremost writers, that in less than two minutes you can turn to any article—needless to wade through all the issues of RADIO-CRAFT which have been published during the past three years.

The RADIO-CRAFT INDEX is exactly the same size as the monthly magazine—it has 24 pages. It can be conveniently kept on file with the copies of the magazine—ready for quick reference. The index is printed on good paper with self covers.

This book is sold only by the publishers at 25c the copy. Mail coupon below for your copy of the RADIO-CRAFT INDEX.

Briefly outlined below appears only a partial contents of the book

- |                     |                    |
|---------------------|--------------------|
| AMPLIFIERS—         | PATENTS—           |
| ANTENNA SYSTEMS—    | PHONOGRAPH REPR.   |
| CABINETS—           | DUCTION AND RE.    |
| CIRCUITS—           | CORDING—           |
| CODE—               | POWER SUPPLY AND   |
| COILS AND TUNING—   | BATTERIES—         |
| COMPONENTS—         | RECEPTION—         |
| COOPERATIVE LABORA- | REMOTE CONTROL—    |
| TORY—               | SELLING AND MDNEY  |
| DETECTORS AND       | MAKING SERVICING—  |
| RECTIFIERS—         | SET CONSTRUCTION—  |
| EDUCATION—          | SPEAKERS AND REPR. |
| INTERFERENCE AND    | DUCTION—           |
| HUM ELIMINATION—    | TELEVISION—        |
| KINKS—              | TONE AND VOLUME    |
| MANUFACTURING—      | CONTROL—           |
| METERS AND TESTING  | TOOLS—             |
| EQUIPMENT—          | TRANSFORMERS—      |
| MISCELLANEOUS—      | TRANSMISSION—      |
| MOTION PICTURE      | TRANSMITTERS—      |
| RECORDING AND       | TUBES—             |
| PROJECTION—         | LIST OF BROADCAST. |
| MUSICAL INSTRU.     | SHORTWAVE AND      |
| MENTS—              | TELEVISION STA.    |
| NEUTRALIZING—       | TELEVISION         |
| NOVELTIES—          |                    |

ABSOLUTELY NOTHING WHICH HAS APPEARED IN RADIO-CRAFT HAS BEEN OMITTED FROM THIS VALUABLE COMPILATION

Clip and Mail Coupon Today!

Publishers of RADIO-CRAFT, RC-633  
96-98 Park Place, New York, N. Y.

Enclosed you will find my remittance of 25c (check, stamps or money order accepted) for which you are to send me, postage prepaid, one copy of the RADIO-CRAFT INDEX.

Name \_\_\_\_\_

Address \_\_\_\_\_

City \_\_\_\_\_

State \_\_\_\_\_

**THIS BOOK CANNOT BE BOUGHT ON THE NEWS-STAND—ONLY DIRECT FROM THE PUBLISHERS 25c THE COPY**

nected. If a couple of strands innocently lean over the adjoining lug, it will be found that several tubes will be blown instantaneously! We have found many cases of this nature.

### RCA 78

Complaints too numerous to mention in which excessive hum and noise are reported on low volume have been traced each and every time to a poor ground, or no ground, connection to the yellow lead.

It has also been a continual complaint that the set's tubes would light up and yet would not function. And this has been found to be due to an "open" 1,100-ohm cathode resistor on the type 56 tubes which drive the 46 tubes in the output stages. (Fig. 2D.)

Hum has been traced to defective 56 tubes. Oscillation was found, in many cases, to be due to various bypass condensers opening up. The simple method of bridging the various suspicious condensers will locate the defective unit in a very short time.

### INFORMATION BUREAU

(Continued from page 748)

show up a poor connection or a shorting lead, it may be necessary to make an ohmmeter test of each circuit in the receiver. Since the set cannot be connected to the power line during this procedure, it may be necessary to simulate operating conditions by heating the chassis with an electric heater.

The "Operating Notes" department of past issues of RADIO-CRAFT contains additional comments concerning this fault in various receiver models. Sure the trouble isn't in the tubes?

(Q.2) What is the circuit arrangement of the Ohmite "Determ-Ohm" Resistance Box? This device is used as a test replacement unit to determine the value of unknown resistors which have "gone west."

(A.2) The circuit of this unit is shown in Fig. Q.199A. Six tapped, wire-wound resistors are used as shown; each unit measures 6x½ ins. in dia. This "decade" box may be used to determine the value required for a replacement resistor, or it may be used as a multiplier for voltmeters in circuits where the applied voltage does not exceed 600. The manner in which the kit of parts is assembled is shown in the picture, Fig. Q.199B.

### ECONOMY EIGHT

(Continued from page 753)

turned over every few minutes. You simply turn the set so that it rests on the tube shields and the gang condenser, with an additional prop under the power transformer, and you then do the whole job without moving the chassis. The dial light wires are fished up after the set is turned around and is ready to be hooked up to antenna and speaker.

### FRANKLIN 100

The Franklin auto-radio receiver, described elsewhere in this issue, is a set that has been in the field for some time now. To facilitate servicing this receiver and to facilitate its installation, the diagram below is given.

Note that the set is mounted on the steering column, the loudspeaker under the dash, and the aerial under the chassis.

Compare this figure with the description given in the front of the magazine.

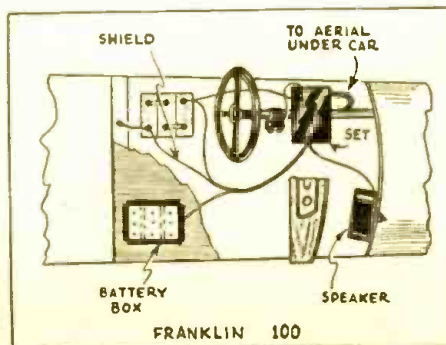

Now—  
all 5 in one set  
to satisfy every  
service requirement

COMPACTLY housed in a single carrying kit, Weston now offers the complete set of 5 Standardized Service Units: Analyzer, Volt-Ohmmeter, Test Oscillator, Tube Checker and Capacity Meter. The combination is a portable laboratory that makes intelligent servicing of any set easy and certain. It contains every instrument for making both Point-To-Point and Tube Checker-Analyzer tests as desired.

With the addition of this 5 unit set Weston has rounded out its line of Standardized Service Unit combinations. Those who prefer the Tube Checker-Analyzer method will want the set containing the Test Oscillator, Tube Checker and Analyzer. For those who prefer the Point-To-Point method Weston offers the kit containing a Test Oscillator, Capacity Meter and Volt-Ohmmeter.

Bear in mind that each unit is entirely independent and can be bought and used separately. It can then be combined in the multiple unit case at some later date. We will be glad to furnish detailed description.

Write to... Weston Electrical Instrument Corporation, 599 Frelinghuysen Avenue, Newark, New Jersey.

**WESTON-JEWELL**  
Radio Instruments

WESTON ELECTRICAL INSTRUMENT CORPORATION  
599 Frelinghuysen Ave., Newark, N. J.

Please send me further information  
on Weston-Jewell Service Equipment.

Name \_\_\_\_\_  
Address \_\_\_\_\_



# UNIVERSAL

Steering Post Remote Control for Auto Radio



Exclusive Features!

\$5.00 List

**KEY LOCK SWITCH AND VOLUME CONTROL**—Prevents tampering with battery—enables accurate volume adjustment without affecting tone quality.  
**MICROMETER TUNING**—Accurate calibrated illuminated scale permits hairline adjustment through proper gear reduction.  
**ILLUMINATED DIAL**—Indicates when set is ready for operation.  
**DRIVE SHAFT**—Ingeniously designed cable prevents slack or back lash when tuning; cable has been serpentine under dash board.  
**ESCUTCHEON**—Calm embossed old bronze finish blending with car hardware.  
**CONTROL HOUSING**—Pressed steel black japanned embodying exclusive engineering features.

### TWO TYPE UNITS AVAILABLE

**TYPE L CONTROL**—Single cable drive control for tuning the variable condenser. Volume control part of remote control functioning as combination key lock switch and volume control.

**TYPE R CONTROL**—Double cable drive for tuning alignment. The other operates by means of the key switch attached to the combination switch and volume control which is an integral part of the receiver.

If your jobber cannot supply you, send your order directly to us.  
**UNITED SCIENTIFIC LABORATORIES, Inc.**  
 62 West 14th St. New York, N. Y.  
 MAKERS OF RADIO PARTS FOR 12 YEARS  
 A few territories open for Jobbers and Dealers.  
 Write for complete details.

## Test All the NEW Tubes with This New and IMPROVED Instrument The E 34 TUBE CHECKER

Tests all 4, 5, 6 and 7 Prong Tubes including the new 15 and 25 volt series. Gives short test; Grid Change Test; Oscillation Test and Total Filament Emission Test—Provision made for future type tubes—voltage regulation 90-130 volts—top with handle provided.



SOLD ON TEN DAYS TRIAL—MONEY REFUNDED IF NOT SATISFACTORY.

E 34 with 3/4" D'Arsonval Meter.....\$21.50

E 33 A, same but with vane type meter .....\$17.80

Circular on request

**L & L ELECTRIC COMPANY**

336 Madison Ave. Dept. 1-A Memphis, Tenn.

## AUTOCRAT AUTO RADIO

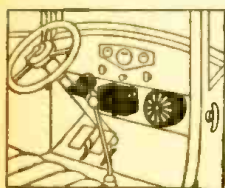

### 6 TUBE

Quality—Tone—Selectivity and Power

Complete \$29.40—includes set, remote control, suppressor kit, tubes, mounting brackets, dynamic speaker. Set only \$10.75. Also 4-5-6 Tube Midgets with latest tubes at low prices.

Write today for our free catalogue.

**AUTOCRAT RADIO CO.**

3855 N. Hamilton Ave.

Chicago, Ill.

## SERVICING A.C. HUM IN SETS AND AMPLIFIERS

By SIDNEY FISHBERG

THE servicing of A.C. hum is generally a difficult problem because this fault is one which is not generally indicated by meters or analyzers. It is a type of fault which can be best serviced by a systematic procedure which first traces down the fault to its source and then takes steps to eliminate it. We advise to say "systematic" because random stabs at the problem will do nothing but waste time, and needlessly rip up the chassis.

The causes of excessive hum may be divided into two general classes: those caused by improper or defective filter or bypass condensers, and those caused by induction hum. The latter type of hum is caused by the field of the power transformer or filter choke, which crosses the fields of the audio transformers or similar units and induces a 60 cycle voltage in them. Induction hum is not usually found in commercial sets or amplifiers except, perhaps, when an audio transformer has been replaced. It is more commonly found in home built apparatus. The instructions given below are useful both to the serviceman repairing commercial sets and the experimenter who has run into difficulty in building a set or amplifier.

The method of locating the faulty component in the set consists of shorting out one part of the set at a time in a logical sequence until the hum disappears. The stage at which the hum is stopped is obviously the one which is causing the trouble. Then, knowing the various causes of hum, it is a simple matter to pick out the defective unit and replace it.

When servicing a set for hum, it should be turned to a point on the dial where no station comes in, and the volume control turned to maximum. The ground, of course, should be connected. The R.F. portion of the set may be checked as a unit, since A.C. hum rarely, if ever, originates in this portion of the set. This check is made by shorting the R.F. coil feeding the detector stage with a piece of copper wire. If there is no change in the intensity of the hum, it is safe to assume that the cause of the hum does not lie in the R.F. portion of the set. If the hum stops, however, upon the application of this test, there is some fault—usually poor shielding or a defective filament bypass condenser (in sets using type 26 R.F. tubes). With modern high gain super-het receivers, there may be some induction hum in the I. F. transformers.

The set may have a peculiar fault in which hum appears only when a strong signal is tuned in, and makes the speech and music "gargly" or "buzzy" instead of remaining in the background like other types of hum. This fault is known as "modulation hum" and is due to defective tubes or improper grid-bias voltages. In order to cure it, the suspected tubes should be replaced by others known to be good (since this defect will not be shown by a tube checker), and the grid-bias voltage should be checked. The type 26 tube is especially critical in regard to correct bias.

The next unit to be tested is the detector stage itself. The grid leak and condenser should be shorted out to see if any hum is being induced into the grid of the detector tube. This type of hum often occurs in short-wave sets, and may be cured by keeping the grid leak and condenser off the chassis, using a very short grid lead, and shielding the detector tube. If there is no change in hum level when the leak and condenser are shorted, this portion of the set is O.K. In plate circuit detectors, the grid-bias resistor should be shorted out to check up on hum at this point, which is usually due to an open bypass condenser. The plate circuit of the detector tube should then be checked for induction hum and insufficient bypassing by shorting out the primary of the audio transformer. If the hum ceases, it is an indication of either induction hum or an open or low capacity bypass condenser. This bypass condenser should first be checked up; and if it is O.K., then the fault is induction hum. This may be remedied by shifting or tilting the transformer until the hum is reduced or eliminated. If this is impossible, the hum may be greatly mitigated by shunting the secondary of the audio transformer with a resistor of 100,000 to 250,000 ohms. This will cut down the hum, while affecting the gain very little.

Here's a book you'll need this summer



64 Pages  
 Size 6 x 9 inches  
 Over 65 illustrations  
 Stiff, Flexible covers

50c

## Automobile Radio and Servicing

By LOUIS MARTIN

There is no question of the fact that the automobile radio set is here to stay. In an experimental stage for three years, automobile radio sets are now being installed into cars by the larger automobile manufacturers as a standard accessory, but there are, of course, actually millions of cars not equipped with radios today and millions of such cars will be so equipped during the years to come.

Automobile radio is an art all of its own. It must be treated by radically new methods because the functioning of the automobile set is more difficult than other types. In such a set we have neither a real aerial nor ground. On the other hand, there is an electrical ignition system which makes it impossible to use an ordinary radio set due to the interference set up.

Automobile radio is up and coming. Millions of cars will have to be serviced. Someone has to service them. It is certain that your turn will come one of these days, whether you are an experimenter, a car owner or a Service Man.

The book is of course chock-full of illustrations, photographs, diagrams, hookups, etc., to make sure that nothing has been left out.

Herewith some of the more important contents of the book:

**CHAPTER I**—1. Introduction—I. Profits in Automotive Radio; 2. Business Opportunities; II. Automotive Radio Installations—1. The Antenna; 2. The Ground; 3. Location of Receiver; 4. Mechanical Difficulties; 5. Requirements of an Automotive Receiver; 6. Limitations of Volume and Noise Level.

**CHAPTER II**—1. Complete Description of Commercial Automotive Receivers.

**CHAPTER III**—1. Servicing Automotive Receivers; II. The Ignition System; III. General Service Considerations; IV. Effects of Temperature on Power Supply; V. Conclusion.

Gernsback Publications, Inc.,  
 98 Park Place,  
 New York, N. Y.

I enclose herewith 50 cents (check, stamps or money-order accepted) for which send me a copy of your book **AUTOMOBILE RADIO AND SERVICING**.

Name .....

Address .....

City..... State.....



**APPLICATION NOTE ON THE 2B7, 6B7, 55, 75, 77 AND 85 AS RESISTANCE-COUPLED AUDIO-FREQUENCY AMPLIFIERS.**

(Courtesy RCA Radiotron Co., & E. T. Cunningham, Inc.)

The data tabulated on the following page is of particular interest to the engineer designing transformerless receivers of either the universal (A.C. or D.C.) or A-C type, and automobile-radio receivers.

Tabulated below are optimum operating conditions for the 6B7, 75, 77\* and 85 as resistance-coupled audio-frequency amplifiers at each of three plate-supply voltages and with specified values of resistance in the grid circuit of the output tube. The 2B7 and the 55 are not included in the tabulation since the same conditions, excepting for heater voltage, obtain for these types as the 6B7 and the 85, respectively.

The 100-volt plate-supply conditions are of especial interest to engineers designing universal (A.C. or D.C.) receivers, because this is about the maximum plate-supply voltage available due to voltage drop in the rectifier and filter.

The 135-volt plate-supply conditions are of especial interest to engineers designing transformerless A.C. receivers, using the 25Z5 in a voltage-doubler circuit. Although the 25Z5 will give approximately 220 volts output when used in a doubler circuit, the voltage drop in the filter and in the electro-dynamic speaker field plus the regulation drop in the power supply circuit will reduce the voltage available for plate supply to about 135 volts.

\*The data in this note for the 77 is not to be confused with that given in Note No. 1 for the 77 as a biased detector.

The 180-volt plate-supply conditions are of especial interest to engineers designing automobile-radio receivers, since this is approximately the voltage from most auto "B" eliminators or dynamotors.

In the tabulation of optimum operating conditions for each tube type, the column headings have the following meanings:

**PLATE SUPPLY VOLTS**—The voltage applied to the plate through the plate-load resistor.

**GRID RESISTOR**—The grid resistor for the succeeding tube. The value of this resistor must not exceed the maximum value specified in our published data for the tube used.

**BIAS VOLTS**—The bias voltage on the control grid of the amplifier tube.

**SELF-BIASING RESISTOR**—The value of self-biasing resistor required to give the bias voltage. In calculating this resistance for screen-grid tubes, the sum of the plate and screen current must be used.

**SCREEN SUPPLY VOLTS**—The supply voltage for the screen grid.

**PLATE LOAD**—The resistance in the plate circuit across which is developed the output voltage.

**PLATE CURRENT**—The plate current of the tube. In the case of duplex-diode types, this refers to the amplifying tube-unit.

**PEAK OUT**—The peak output voltage developed across the plate-load resistor. The first figure gives the maximum undistorted output voltage obtainable, and the second figure gives the maximum obtainable with some distortion. The output voltage measured across the plate-load resistor alone would be somewhat higher, were it not for the shunting effect of the grid resistor of the succeeding tube.

**VOLT. AMPLIF.**—The voltage amplification obtainable with the tube under the conditions specified. It is to be noted that these data give the voltage amplification obtainable at the grid resistor of the succeeding tube; that is, the a-c load on the amplifier is the parallel combination of the plate-load resistor and the grid resistor of the succeeding tube.

**NOTE:** The coupling condenser between the plate-load resistor and the grid resistor of the succeeding tube should be of adequate capacity to insure good low-frequency response. A capacity of 0.1-mf. is usually the maximum which will be required.

**ELECTRAD**  
*Serves the*  
**SERVICE MAN**

**ELECTRAD** serves not merely manufacturers and experimenters — **ELECTRAD** is keyed up to help the Service Man with entire understanding of his many puzzling problems. Write Dept. RC-6 for catalog of the most complete line of Replacement Resistors, Volume Controls and Direct-Coupled Amplifiers for every purpose. You will find it a useful guide.



\$1  
a year

"It's a great book! Eliminates all doubt."

**THAT** is what thousands of service men say about the new **ELECTRAD 1933 Resistor Replacement Hand Book**. And it is what you will say. *Sold on 10-days' trial, money-back guarantee. Send along your dollar today!*

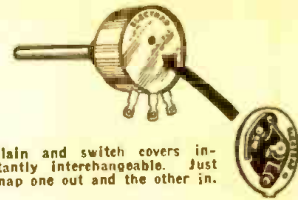

Plain and switch covers instantly interchangeable. Just snap one out and the other in.

**JUST 5 TYPES**  
**of ELECTRAD**  
**Volume Controls**  
**Required to**  
**Service 799**  
**Standard Model**  
**Receivers**

**WHICH** means less investment in stock and fewer parts in the kit.

The shafts are **ALUMINUM**—extra long—easily cut to desired length. Standard cover may be replaced by power-switch assembly, without disturbing control connections.

These Replacement Volume Controls save service time, labor and money.

175 Varitek St., New York, N.Y.  
**ELECTRAD**  
INC.

**ANOTHER STEP FORWARD**

WITH THE NEW



STEERING POST

**AUTO-RADIO**



**INSTALLATION**—Bothersome and expensive—the only objection to Auto-Radio sales is practically **ELIMINATED**

A Compact  
**AUTO-RADIO**

SO SMALL THAT COMPLETE SET CAN BE MOUNTED DIRECT ON STEERING POST AND A

**POWERFUL PERFORMER**



**DEALER AND SERVICEMEN**—Write Your Nearest Distributor or Direct To

**AUTOMATIC RADIO MFG. CO., Inc.**

112 CANAL STREET

BOSTON, MASS.

**TO ALL RADIO MEN!**

The advertisements which appear on pages 746 and 747 of this issue are extremely important. Everyone should turn to these pages **NOW** and read them carefully.



# A NEW REVOLUTIONARY Static ELIMINATOR

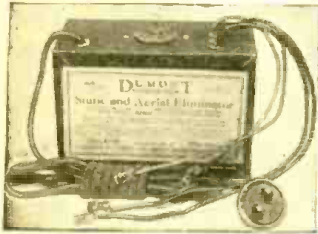

Illustration shows eliminator with leads and plug attachments

Here at last is a device made to eliminate completely man-made static, the type of noises that so often causes discomfort to radio listeners. Quickly it reduces it to a minimum. Disturbances caused by electrical appliances and aerials of all descriptions, and brings in reception with clear, and excellent results. Can be connected in five minutes. Supplied with 75 feet of shielded lead-in wire.

Service Men and Dealers add this money-making radio device to your line—install the Dumont Eliminator in every home where you call to service the set. A lifetime of service is guaranteed for every Dumont Eliminator.

**SERVICEMEN AND DEALERS!** Get our catalog and prices on complete line of replacement condensers, Electrolytic and Paper. They are "Best by Test." Jobbers and representatives territory open. Write today.

### Clip—Mail Coupon Today!

DUMONT ELECTRIC CO., Inc., Dept. RC-6  
453 Broome Street, New York, N. Y.  
Enclosed herewith you will find check or money order for \$2.85. (Regular List Price, \$5.00), for which you are to send me. Postage prepaid, one Dumont Static Eliminator, with complete instructions for operating.

Name.....  
Address.....  
City.....State.....

**Remarkable Freedom  
from NOISE...by use of  
LYNCH**  
Short Wave Antenna System

**HARVEY'S RADIO SHOP**  
HARVEY E. SAMPSON  
105 WEST 43rd STREET  
NEW YORK CITY

Mr. Arthur H. Lynch, March 23, 1933.  
Lynch Manufacturing Co., Inc.,  
General Motors Bldg., New York, N. Y.

Dear Mr. Lynch:

For many years, we have been unable to give satisfactory demonstrations at our store, which is located in the midtown section of New York, because of man-made static.

However, on very high recommendation from one of the leading manufacturers of short wave radios, we put up one of your doublet antenna systems using your transposition blocks.

Words cannot express adequately the results which we are obtaining with same. We have seven different antennas installed in our building, and these coupled together are not fifty percent as good as your transposition system. May we add that this certainly is a contribution to the Radio Art.

Yours very truly,  
HARVEY'S RADIO SHOP.

*Harvey Sampson*

Complete Kit.....\$5.00  
At ALL LYNCH Jobbers and Dealers

If your Jobber, Dealer or Serviceman cannot supply you, order direct from us. Sent post-paid, with instruction booklet, for \$5.00.

Free Descriptive Folder Upon Request  
LYNCH MANUFACTURING CO., Inc.  
711RP—General Motors Bldg.,  
New York, N. Y.  
Makers of the Famous Metallized Resistors

## OPERATING CONDITIONS FOR RESISTANCE COUPLED A-F AMPLIFIERS

TYPES: 6B7, 75, 77, 85

RCA-6B7 and C-6B7

Plate Supply Volts	Grid Resistor Megohms	Bias Volts	Self-Biasing Resistor Ohms	Screen Supply Volts	Plate Load Megohms	Plate Current Ma.	Peak Out. Volts	Volt Amplif.
100	0.25	-2.00	5550	20	0.25	0.27	28-30	35
100	0.25	-2.50	12200	20	0.50	0.15	25-27	36
100	0.50	-2.15	9350	20	0.25	0.23	36-38	47
100	0.50	-2.60	19250	20	0.50	0.13	32-33	46
135	0.25	-1.80	3800	20	0.25	0.35	38-40	36
135	0.25	-2.25	8300	20	0.50	0.20	32-35	38
135	0.50	-1.95	4850	20	0.25	0.30	48-50	53
135	0.50	-2.40	10900	20	0.50	0.16	42-44	56
180	0.25	-2.10	3700	25	0.25	0.43	50-53	50
180	0.25	-2.60	7600	25	0.50	0.26	45-48	53
180	0.50	-2.10	3500	25	0.25	0.45	65-68	63
180	0.50	-2.60	7300	25	0.50	0.26	64-66	70

RCA-75 and C-75

100	0.25	-1.05	10500	....	0.25	0.10	11-16	30
100	0.25	-1.05	15400	....	0.50	0.07	10-14	29
100	0.50	-1.10	11550	....	0.25	0.09	15-19	36
100	0.50	-1.05	15000	....	0.50	0.07	14-19	37
135	0.25	-1.05	6200	....	0.25	0.17	17-23	42
135	0.25	-1.10	9150	....	0.50	0.12	17-21	38
135	0.50	-1.05	5850	....	0.25	0.18	20-30	50
135	0.50	-1.10	10000	....	0.50	0.11	18-27	48

180	0.25	-1.25	4900	....	0.25	0.25	26-33	48
180	0.25	-1.20	7100	....	0.50	0.17	24-30	46
180	0.50	-1.30	5150	....	0.25	0.24	32-40	56
180	0.50	-1.30	9000	....	0.50	0.14	30-38	55

RCA-77 and C-77

100	0.25	-1.10	3760	20	0.25	0.22	15-23	40
100	0.25	-1.25	6450	20	0.50	0.14	17-22	39
100	0.50	-1.05	3400	20	0.25	0.23	16-29	54
100	0.50	-1.25	7250	20	0.50	0.13	18-28	53
135	0.25	-1.20	3100	25	0.25	0.29	21-32	54
135	0.25	-1.37	5600	25	0.50	0.18	27-31	52
135	0.50	-1.27	3750	25	0.25	0.25	29-37	61
135	0.50	-1.42	6300	25	0.50	0.17	34-38	62

180	0.25	-1.25	2180	30	0.25	0.43	31-43	76
180	0.25	-1.50	4550	30	0.50	0.25	36-41	65
180	0.50	-1.30	2600	30	0.25	0.38	36-52	92
180	0.50	-1.55	4850	30	0.50	0.24	45-52	93

RCA-85 and C-85

100	0.25	-4.75	16800	....	0.25	0.28	24-26	6.15
100	0.25	-3.75	25800	....	0.50	0.14	17-22	6.05
100	0.50	-5.00	21200	....	0.25	0.23	27-29	6.60
100	0.50	-5.50	46000	....	0.50	0.12	26-27	6.20
135	0.25	-6.80	21200	....	0.25	0.32	34-36	6.15
135	0.25	-4.75	24300	....	0.50	0.19	27-30	6.10
135	0.50	-7.00	22000	....	0.25	0.31	38-42	6.50
135	0.50	-7.00	42500	....	0.50	0.16	36-40	6.35
180	0.25	-7.50	16300	....	0.25	0.46	38-40	6.45
180	0.25	-7.00	28000	....	0.50	0.25	36-38	6.40
180	0.50	-7.00	14900	....	0.25	0.47	40-44	6.75
180	0.50	-7.50	31200	....	0.50	0.24	40-45	6.50



## R M A STANDARDS

In response to numerous requests, RADIO-CRAFT presents below a recent report of the various committees on standardization of the Radio Manufacturers Association. Courtesy is extended to the RMA for this reprint.

### Report of Sub-Committee on Electrolytic Capacitors and Engine Compartment Temperature

#### I Purpose.

The purpose of this Committee was to determine the safe operating temperatures for electrolytic capacitors; to determine the approximate temperatures encountered in various positions suitable for mounting radio receiving equipment containing such capacitors; and to make such recommendations as seemed desirable relative to such mountings. This report covers the above questions.

#### II Operating Temperature of Electrolytic Capacitors.

A. Two definite variables are introduced by temperature change. The capacity varies directly as a function of temperature. The expected life is not so directly related, as it bears a definite ratio to the leakage current expressed as coulombs. However, this leakage current becomes a function of temperature after a critical temperature value is reached.

#### B. Temperature effect upon capacity.

It has been found possible to develop electrolytic capacitors capable of performance between the temperature limits of -10 degrees C. and 82 degrees C. A decrease in capacity to approximately 50% of that at 15 degrees C will be observed at the lower temperature limit. No harmful effects may be expected if the temperature is still further decreased, other than a further decrease in capacity, which ultimately will approach zero if the temperature be dropped sufficiently. The increase in capacity for temperatures higher than 15 degrees C will not be so marked. Receiver designs for cold operation should consider this capacity variation.

#### C. Temperature effect upon leakage.

Leakage current may be expected to increase rapidly after a temperature of 85 degrees C has been reached. The life of the capacitor will be very short, if this leakage current is permitted for any appreciable period of time. It, therefore, limits the upper operating temperature limit to approximately 82 degrees C or 180 degrees F. This temperature may be considered as a safe maximum.

#### III Engine Compartment Temperature.

The temperatures encountered may be classified with respect to their source. They reach the receiver by means of conductor through the heated metal part upon which the receiver is mounted and through the air stream surrounding the motor. By far the highest temperatures are caused by conduction through metal parts, and care must be used to reduce the actual contact area between the receiver and the motor block or crankcase at an absolute minimum. The metallic path between these points and the receiver should be as long as possible. Temperatures of a high order, 70 degrees C (165 degrees F.) to 80 degrees C (175 degrees F.) have been observed in rare cases, and from 45 degrees C (110 degrees F) to 55 degrees C (130 degrees F.) are generally encountered beneath the hood of a motor car, when it is exposed to the direct sun and there is little or no circulation of air. These temperatures may exist for an extended period. It has been determined, however, that this source of temperature rise has little or no influence upon the operating temperature of the motor compartment and drops the instant the motor is started, owing to the air circulation. Ducts near the upper side of the hood should completely eliminate this source of heat by convection currents through these ducts.

Heat from the cooling system of the car (radiator) is probably the largest part of the heat encountered while the car is in motion. Behind the radiator and between the fan and the motor block the temperature rise was 30 degrees C plus or minus 2 degrees C (50 to 55 degrees F.). This test was made at 60 M.P.H. under Florida sun and with a temperature of 30 degrees C (86 degrees F.) ambient, after motor had reached maximum temperature. It thus seems probable that the maximum temperature existing under

(Continued on page 761)

## CONSIDER THESE GREAT FEATURES FULLWAVE "B" POWER SUPPLY

FOR...AUTOMOBILES...STEAMSHIPS...MOTOR BOATS...FARMS  
the only unit incorporating the automatic load delay circuit,  
completely eliminates "B" battery replacement, supplies steady and  
continuous power, makes Auto Radios all electric like home sets.

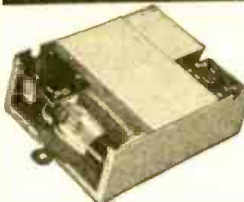

Operates from either a 6 volt or 12 volt batteries, or 32 volt Delco Systems. Draws 1 1/4 amperes and delivers up to 200 volts. Equipped with variable intermediate voltage. Supplies Pure D.C. to any automobile or home receiver having as many as 8 tubes. The only auto Eliminator equipped with the SPECIAL AUTOMATIC LOAD DELAY RELAY FULL-WAVE INTERRUPTER FULL-WAVE RECTIFIER. Equipped with an automatic relay that turns the receiver on and off. Installed in a jiffy. The size of one 45 volt "B" battery. Housed in a sturdy steel, shock-proof cadmium plated case with a two hole mounting to facilitate rapid installation. QUIET AND PERMANENT. No attention, no oiling. Takes the place of four 45 volt "B" batteries and lasts a lifetime.

LIST OF PARTS	
Transformer	\$1.26
Full-Wave Vibrator	2.80
Load Delay Relay	.64
On-Off Relay	.64
R.F. "A" Choke	.22
A-F. Choke	.82
Dual 8 Mfd. Condenser	.90
7500 Ohm Resistor	.22
20 Mfd. By-Pass Condenser	.72
Dual .02 Mfd. Condenser	.22
Variable Voltage Divider	.54
"B" Strip Terminal	.36
"A" Strip Terminal	.10
Socket	.46
Miscellaneous Hardware	.46
Regular Price	\$10.12
SPECIAL OFFER: Complete	7.95

POSTAL "B" ELIMINATOR KIT AS LISTED..... \$ 7.95  
Three Piece Case and Chassis..... 1.95  
Full-Wave Mercury Vapor Rectifier..... 1.36  
Regular Price..... \$11.26  
SPECIAL OFFER: as listed above..... \$ 7.95  
COMPLETE ELIMINATOR WIRED READY TO OPERATE..... \$11.80  
INDIVIDUAL PARTS OF KIT AVAILABLE at prices listed

**POSTAL RADIO** **\$7.95** KIT FORM  
135 K LIBERTY STREET NEW YORK, N. Y.

## Announcing RADIO CITY'S NEW Multitester

MODEL 401 PERMITS TRIPLE TESTING WITH SINGLE METER



Combined voltmeter-ohmmeter-milliammeter is compact—essential to dealers and Service Men. TRIPLE-RANGE OHMMETER—from 1/4 to 2,000,000 ohms. FOUR-RANGE VOLT METER—0-5, 0-50, 0-250, 0-750 volts. Sensitivity 1000 ohms per volt. TRIPLE-RANGE MILLIAMMETER—0-5, 0-50, 0-250 milliamperes. Automatic selector switch prevents possible burnouts. 3 1/4" D'Arsonval type moving coil meter with an within 2%. Compact, portable, etched panel, crystalline finish. Self-contained batteries and test leads with detachable alligator spring clamps. Case, 5 1/2 x 8 1/2 x 4 1/2 inches.

**\$15.00** net  
(in knockdown kit, less batteries and test leads)  
List \$27.50

**\$20.00** net  
(completely wired and assembled, includes batteries and test leads)  
List \$37.50



DOUBLE RANGE OHMMETER and CIRCUIT TESTER (as illustrated on the right) tests from 1/2 to 200,000 ohms. Complete

**\$11.95**

RADIO CITY PRODUCTS CO. 48 West Broadway New York, N. Y.

### AUTO RADIO

There are many kinks to look for in servicing an auto-radio receiver that do not occur in the servicing of the more conventional "home" sets. Of major consideration is the problem of "noise." Pages upon pages have been written on the procedure to follow in locating the source of noise in an auto. One interesting account was spilled to the editors by our own Bertram M. Freed, of "Operating Notes" fame.

"I hunted and hunted until I was sore," he declared. "I made the startling, but nevertheless unfortunate, discovery that almost every part of the engine I tested was the source of noise. If I shielded the distributor leads, the noise seemed to increase from the area surrounding the coil. Regardless of what I tried, the noise persisted. There were only two occasions when I had no noise: when the set was shut off, and when the motor was not running.

"Finally, I decided to finish the job the next day, at which time I expected my spirits to rise sufficiently to enable me to think of something more remunerative. Besides, the wife decided that it was high time I quit for the day. And so I quit (will Service Men's wives ever become scientific?), not because the wife said so, mind you, but because I thought(?) it was a good idea.

"The following day I attacked the problem with renewed vigor. The more I tried, the less I accomplished, until lunch time. The owner of the car (?) drifted in during a spell of prolonged expostulation, and aimlessly glided from one side of the car to the other, commenting on its condition, and telling me what the bus needed to put it in shape.

"He strolled to the motor, glanced at the conglomeration of wires, dirt, and filth, and naively mentioned that the motor needed a washing. I suggested the same thing, more to get a rest than to see the thing clean.

"And when the bus arrived after a motor washing there was absolutely no noise! Not even a wee bit of noise.

"The dirt, it seemed, caused enough leakage to make every part of the engine noisy."

## Field Coils

FOR ANY MAKE OF RADIO SPEAKER

Jobbers, Dealers and Service Men write for our attractive prices. Every coil we manufacture is guaranteed to be made from new BELDEN wire and an exact duplicate of the original.

Radio Service and Supply Co.  
310 Dexter Avenue, Montgomery, Ala.

## BRING IN NEW and DISTANT

Stations with this  
**AMERICAN**  
ALL DIRECTION  
ANTENNA

Coast to coast reception is possible. Gives clearer and louder reception. Gets greater distance and volume. Made of copper. Neat and durable. Easily and quickly installed. Guaranteed.  
**PRICE NOW \$1.00 PREPAID**  
**AMERICAN RADIO HARDWARE CO.**  
137 Grand Street, New York, N. Y.  
Agents write for exclusive territory

## FREE RADIO CATALOG

**WORLD'S FAIR ISSUE JUST OUT**  
Write for FREE catalog today. Most complete line of radio sets, service men's supplies, replacement parts, test equipment, at lowest wholesale prices.  
**ALLIED RADIO CORP.**  
633 W. Jackson Blvd. CHICAGO



This

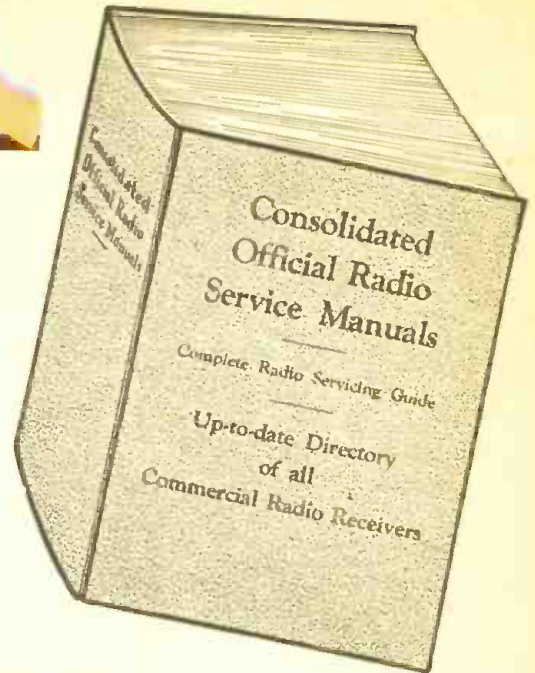

## Radio's GREATEST Servicing Book

*The Most Complete Directory of Radio Circuit Diagrams published!*

**In ONE VOLUME of over 2,300 Pages  
Extra Heavy Cover—Looseleaf Bound**

Buy this Big Volume on our *New*

# DEFERRED PAYMENT PLAN

Here are two of the most surprising announcements that we have ever made to the radio trade and we know that it is such good news that every radio man will be greatly enthused.

FIRST—that the three editions of the OFFICIAL RADIO SERVICE MANUALS have now been combined into one big volume of over 2,300 pages.

SECOND—that this new single volume of consolidated radio circuit diagrams and complete radio servicing course can be bought on a deferred payment plan—and at a big saving.

It is needless to say how valuable the OFFICIAL RADIO SERVICE MANUALS have been to members in every branch of the Radio Industry, and how many thousands of each edition have been sold to manufacturers, jobbers, dealers, Service Men and experimenters. But we must emphasize this one fact: Service Men now realize that they are tremendously handicapped without the full set of Gernsback Manuals. So much so, that those who have purchased only one or two volumes, are NOW ORDERING THE MISSING BOOKS. They want their files to be complete.

The complete book gives you a volume of over 2,300 pages with over 5,500 diagrams, charts and photos. There are absolutely no pages or illustrations or diagrams duplicated. There is no radio book published today which is so modern, up-to-the-minute, and which contains so much useful information as is to be found in this single volume. It is a book that will outlast any other radio book in print. Look carefully at the illustration of the complete edition on the top of page. It measures 9" wide, 12" long, 4½" thick.

Included in this volume is a complete radio servicing course. This course covers every step needed to learn the servicing business . . . from starting in business . . . materials needed . . . and how to go about servicing receivers and repairing other radio equipment. This course in itself, is actually worth the price of the entire book.

Our new plan now enables every radio man to get this single volume—a Complete Directory of all Circuit Diagrams, of over 2,300 pages, on deferred payments. You can order this book immediately—get it in a few days, and use it while you are doing servicing work. You can make the first few calls pay for the entire cost of the book.

For you to get this book is quite simple and it is sent to you as soon as your order is received. You pay for it in small monthly amounts which can be taken from your earnings. If you were to buy the three volumes separately, the total cost would be \$17.00, including the supplements.

Now you can get the

1931 OFFICIAL RADIO SERVICE MANUAL, with Supplements,  
1932 OFFICIAL RADIO SERVICE MANUAL, with Supplements,  
and the 1933 OFFICIAL RADIO SERVICE MANUAL Complete

at a big saving.

THE SPECIAL NEW PRICE FOR ALL THREE MANUALS, WITH SUPPLEMENTS, IN ONE VOLUME, WITH HEAVY BINDER IS ONLY

### \$14.00

You buy this book this way—

Send \$3.00 with order—

Pay \$5.00 to Express Company upon receipt of book.

Send \$3.00 thirty days after receipt of book.

Send \$3.00 sixty days after receipt of book.

Total \$14.00.

IF THE ENTIRE AMOUNT IS SENT WITH YOUR ORDER, WE WILL ALLOW YOU A 10% DISCOUNT. THIS CAN BE DEDUCTED FROM YOUR REMITTANCE.

**IMMEDIATE SHIPMENT**

**Mail Coupon Today!**

GERNSBACK PUBLICATIONS, Inc.,  
96-98 Park Place, New York, N. Y.

Gentlemen:  
In accordance with your Special Offer, I enclose herewith \$3.00 as first payment toward the One-Volume Radio Manual. Please forward it to me promptly. Upon receipt of the book, I shall pay express company \$5.00. Thirty days later I shall send you \$3.00, and sixty days after receipt of book, I shall send you my last payment of \$3.00.

If you want to take advantage of the Special Discount of 10%, remit only \$12.60 with this coupon.

Name \_\_\_\_\_

Address \_\_\_\_\_

City \_\_\_\_\_ State \_\_\_\_\_

RC-633

# OVER 2,300 Pages 5,500 Illustrations

## THIS IS THE GREATEST SINGLE VOLUME RADIO BOOK IN PRINT TODAY

GERNSBACK PUBLICATIONS, Inc.

96-98 Park Place

New York, N. Y.





No. 2

## FUNDAMENTAL PRINCIPLES OF RADIO

Radio Simply Explained—Its Origin, Nature and Functions  
By LOUIS MARTIN

Prepared with special consideration given to young members in the radio profession, and those who have gained their experience in a haphazard fashion. This radio primer is a handy fundamental aid for "checking up" and systematizing your knowledge of radio. Regardless of how much you know about the subject, you should read this book.

### PARTIAL CONTENTS:

Chapter I—Fundamentals of Radio: Electricity, Resistance, Batteries, The Magnetic Circuit, The Magnetic Field, Inductance, Condensers, A.C. Circuits, Propagation of Radio Waves; Chapter II—The Simple Radio Set, Single, Two, and Three-Circuit Tuners, The Battery Set, Vacuum Tubes, Electric Sets, Loud Speakers; Chapter III—Diagrams, How to Read Them; Chapter IV—Amateurs and Broadcast Stations, Talking Pictures, Television.

No. 1

## FORMULAS and RECIPES

For the Practical Man  
By S. GERNSBACK

An extremely helpful book showing you how to save money by making in your own home, at a fraction of the regular cost, the hundred and one preparations which you now buy for use at home or business.

### PARTIAL CONTENTS:

1. Adhesives; Glues, Cements. 2. Cleansing; Stain Removers, Bleaches. 3. Metal Craft; Coloring, Oxidizing, Plating, Polishes. 4. Paints; Colors, Stains, Varnishes. 5. Glass-Working; Cutting, Drilling, Boring, Etching, Engraving. 6. Wood-Craft; Fireproofing, Acid-proofing, Waterproofing, Furniture Polishes. 7. Inks; Sympathetic, Invisible, Hectograph. 8. Photography; Developers, Emulsions, Fixers. 9. Antidotes for Poisons, Remedies for Burns and Scalds, Disinfectants. 10. Preparation, Manipulation, Handling, Mixing, Tables of Weights and Measures. Useful Tables.

No. 3

## ELEMENTARY MATHEMATICS

for the Technician and Craftsman  
By C. SHAINMARK

This manual has been especially prepared for the man who wishes to acquire a working knowledge of the elementary principles of mathematics. A complete treatment of the subject is given by the author, Mr. C. Shainmark, with special attention to the use of mathematics in Radio and other technical work for those who employ its formulas daily.

### PARTIAL CONTENTS:

I—Arithmetic: Addition, Multiplication, Subtraction, Division, How to Use Decimals; II—Fractions, Percentages, Ratio and Proportions; III—Powers and Roots; IV—The Metric System; V—How to Measure Surfaces and Volumes; VI—Mathematics for the Manual and Technical Craftsman; VII—Special Mathematics for the Radio Technician; VIII—Commercial Calculations, Short-cut Arithmetic, Interest Calculation, Discounts; IX—Weights and Measures; X—Useful Tables.

All our books are of uniform size, 6 x 9 inches, and contain 64 pages. The books are printed on strong paper with stiff colored covers.

PRESS GUILD INC., 16 Murray St., New York, N. Y.

ANY TWO BOOKS FOR 85¢ postpaid.

ALL THREE BOOKS FOR \$1.25 postpaid.

Enclosed find \$..... for which mail me postpaid the following books:

No. 1  No. 2  No. 3   
Single copy 50¢ Postpaid

Name .....

Address .....

City and State.....

RC-633

## RMA STANDARDS

(Continued from page 759)

driving conditions may be within 10 degrees C of this figure.

Temperature rise from various points on the motor indicates that excessive heat may be expected adjacent to or in contact with the upper section of the crank case. This has been observed to reach temperatures as high as 110 degrees to 120 degrees C (220 degrees to 250 degrees F.). It is, therefore, deemed inadvisable to mount any component of the receiver in the relatively low position.

Temperatures near the exhaust manifold, of course, reach excessively high values, and no equipment was available to measure these. In any event, the receiver should not be mounted near this manifold.

### IV Conclusion.

A. Electrolytic capacitors may be operated up to 82 degrees C or 180 degrees F. Short periods (several minutes possibly) at higher temperatures produce no permanent damage.

B. Temperature measurement shows it practical to mount the radio receiver in the engine compartment. Temperature rise of 30 degrees plus or minus 5 degrees Centigrade (45 degrees to 55 degrees F.) above ambient may be expected. Peak temperatures of high value but short duration may be expected upon stopping the engine with poor circulation. This might become troublesome in southern locations.

C. It is recommended that the receiver be installed upon the engine partition on the side opposite the exhaust manifold and as high as possible.

### Report of RMA-SAE Committee on Wiring for Installation of Auto Radio Receivers, at Meeting held at the Book-Cadillac Hotel, Detroit, January 19th, 1933

The members of the RMA Committee have not had an opportunity to meet as yet with the SAE Committee, and consequently, a joint report is not available.

However, the following recommendations will be taken up for consideration by the Members of this joint committee, and a report will be submitted at the next meeting:

(1) The lead from the ignition coil to the distributor breaker should be shielded, the shielding to be well grounded. In the event that it is inadvisable to shield this lead, it should not run through the conduit or manifold with the secondary or high tension wires. It should be run or placed as far away from these leads as possible in order to cut down the induced surges as much as possible.

(2) The lead from the battery terminal to the ammeter should be shielded and shielding grounded at the battery and at the dash. Also the lead from the ammeter to the ignition switch and from the ignition switch to the coil should be shielded and shielding grounded.

(3) The ignition switch should be entirely enclosed in a metal container where the switch is located in or around the dash.

(4) In all cases it is recommended that those motors or engines which are supported by material which is in itself an insulator or poor conductor, such as rubber, springs, etc., that the motor be bonded with a flexible copper braid or strap at at least two places, one being the frame of the car and the other being to the bulkhead or fire-wall.

(5) It is advisable wherever a dome light is installed in the body that the antenna be kept as far away from the dome light as is allowable with a minimum of 4" due to shunting effect which is present wherever the antenna is too close to the dome light or dome light leads.

(6) The dome light should be so constructed wherever possible as to entirely be enclosed in metal at the back and for best experience it should have a shielded wire leading from the dome light down to its switch with a wire also shielded from there to the ammeter as this wire is the closest one to the antenna and as it is also connected to a source of interference, it is important that the antenna be kept as far away from these dome lights and dome light lead wires as possible, and that its interference effect be even further minimized by shielding it, the shielding could be used as a ground return circuit for the dome light. However, it is advisable to ground the shield to the body at the nearest point possible as well as at at least one other place beside the other end or ammeter side.

(Continued on following page)

## The ECONOMY EIGHT

Here's how you can build it for

\$13.75

The ECONOMY EIGHT is well named! It is simple in design; easy to build—and you can now buy the Complete Kit of Parts from WHOLESALE RADIO SERVICE CO. for only \$13.75!

What a radio this is! It has everything! Great Tone Quality, Sharp Tuning and High Sensitivity! Here is a new receiver which uses the latest tubes in improved circuits. Write for details of this GREAT BUY!

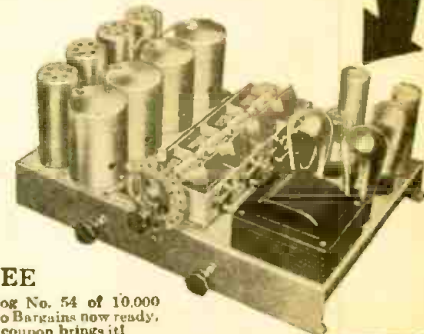

FREE

catalog No. 54 of 10,000  
Radio Bargains now ready.  
The coupon brings it!

WHOLESALE RADIO SERVICE CO.,  
100 SIXTH AVE., NEW YORK, N.Y.

Gentlemen: Dept. C-63  
Send me details of the "ECONOMY-8";  
also Catalog No. 54.

Name .....

Address .....

Town .....

State .....

## Voltage and Resistance Measurements

95% of radio-set troubles can be located quickly and accurately with the



SHALLCROSS

No. 681

Quick-Change

Volt-Ohmmeter

10 - 100 - 500 - 1000 volts  
1 ohm to 3 megohms

This instrument is very easy to build. The important parts

required are a 1-milliampere D.C. meter and the SHALLCROSS Resistor Kit No. 681.

Send 6c in stamps for Bulletin 681-P, describing the service man's most useful test instrument.

Shallcross Mfg. Company  
ELECTRICAL SPECIALTIES  
700 PARKER AVENUE  
Collingdale, Pa.



UNIVERSAL  
Protected Diaphragm Type  
1933 MODEL "X"

Here is microphone value without precedent! A brand new, 1933 model, protected diaphragm type, 5-button microphone, listing at only \$10.00! Exceeds every reasonable requirement for quality performance.

UNIVERSAL MICROPHONE CO., Ltd.  
424 Warren Lane, Inglewood, Calif., U. S. A.



# SERVICEMEN.....

## Here It Is At Last THE STANDARD ANALYZER PLUG

Last month we announced the seven prong analyzer plug with the 59 base. THIS MONTH we announce a brand new plug. This is a seven prong plug but has the base of the new small seven prong tubes—2A7, 2B7, 6A7, 6B7, etc. With the 59 being the only medium based seven prong tube and the trend being to use the new small seven pin base, this new plug is being adopted as standard. The storm of new tubes has blown over. Now is the time to modernize your equipment with this standard plug and its brand new associate adapters which fit into the closest of the closely shielded sockets.

**EQUIP YOUR ANALYZER WITH THIS PLUG AND BRING IT UP TO DATE. DIAGRAMS AND DIRECTIONS SENT FREE WITH ALL ORDERS.**

**907WCLA** New Small Size Seven Prong Na-Aid Latch Lock Analyzer Plug with Twin C. G. Handle and five feet of EIGHT wire cable attached.  
**907WCLA** (as described) List price, \$5.50  
**907WL** Same without cable List price, \$3.50

This plug fits the latest small seven sockets. For UX 4-hole sockets the **974DSA** adapter is snapped onto the plug; for UY 5-hole sockets the **975DSA** is used; for 6-contact sockets the **976DSA** and for the 59 seven contact socket the **977DSA** is required. Each of these four new SMALL SIZED associate adapters, **974DSA, 975DSA, 976DSA** and **977DSA** have a list price of \$1.25 each.

**REPLACE YOUR OBSOLETE SOCKETS WITH THESE LATEST COMPOSITE SOCKETS**

**456** replaces sockets requiring a 1 3/16" panel hole and 1 19/32" mounting hole spacing, for contacting all 4, 5 and 6 prong tubes. Filament circuit common—all others isolated—has nine contacts. List Price, \$ .50  
**456E** replaces sockets requiring a 1 3/16" panel hole and 1 19/32" mounting hole spacing, for contacting all 4, 5 and 6 prong tubes. List Price, \$ .60  
**477** matches the **456** but receives all seven prong tubes of both type bases. Has seven contacts. List Price, \$ .50  
**477E** same as **477** but matches the **456E**. List Price, \$ .60  
**457** receives the 47 5-prong pentode and the 59 7-prong pentode. Cathode of 59 isolated from the screen-grid of the 47. Has eight contacts. List Price, \$ .50

**457E** same as **457** but has "E" mounting. List Price, \$ .60  
**567** receives all 5, 6 and small 7 prong tubes. Has seven contacts. Composite **567** socket. List Price, \$ .50  
**567E** same as **567** but has "E" mounting. List Price, \$ .60  
**437E** for the 59 medium based 7-pin tubes. List Price, \$ .40  
**437** receives the small based 7-pin tubes. List Price, \$ .35  
**437EA** for all small based 7-pin tubes. List Price, \$ .40  
**437A** same as **437EA** but with 1 19/32" mtg. List Price, \$ .35  
**425** six-contact socket with 1 19/32" mtg. List Price, \$ .25  
**425E** five-contact socket with 1 19/32" mtg. List Price, \$ .25  
**424** four-contact socket with 1 19/32" mtg. List Price, \$ .25

**HERE'S THE QUICKEST, LOWEST COST METHOD OF MODERNIZING YOUR ANALYZER**

**965DW** Enables any analyzer which can test 24 circuits to test all the new 6 prong tubes. List Price, \$2.50  
**965DSW** Same with locking stud. List Price, \$2.50  
**975DW** Enables any analyzer which can test 24 circuits to test all the new 7 prong tubes. List Price, \$3.00  
**975DSW** Same with locking stud. List Price, \$3.00  
**975DWA** For analyzing the new small prong tube circuits. List Price, \$3.00  
**975DWA** Same with locking stud. List Price, \$3.00

**TREAT YOUR OUTPUT METER TO THIS ADAPTER**

This 9PL Output Meter Adapter contacts the plate prongs of 4, 5, 6 and 7 prong tubes whether having a small or regular base—insulated for use in the new close fitted shielded sockets and equipped with a serviceable 5 foot lead. May also be used for connecting pickups, microphones, phones, extra speakers, tone controls, voltmeters, etc. **9PL** List Price, \$ .50

**GET THIS ADAPTER TO MODERNIZE YOUR TUBE CHECKER**

**950XYL** Universal Tube Checking Adapter tests over 80 NEW TUBES. No wires, no leads—no sockets—very simple to operate. Circuit diagram and direction chart listing over 80 NEW TUBES with where for recording resistance of these and future tubes are supplied with all orders. List Price, \$6.00

If your tube checker has no filament-voltage switch the **954XGL** adapter must be used on the base of the **950XYL**. **954XGL** UY top-UX bottom—with C. G. lead. List Price, \$1.25  
**975-AB7** Small 7 tube checker adapter. List Price, \$1.00

**"MAKE-YOUR-OWN" ADAPTERS**

For those who wish to use tube base sections for making their own adapters we have available the following tube-bases and top socket sections:

<b>304</b> 4 prong tube base.....10c	<b>422</b> 4 hole socket top.....25c
<b>305</b> 5 prong tube base.....10c	<b>423</b> 5 hole socket top.....25c
<b>306</b> 6 prong tube base.....10c	<b>426</b> 6 hole socket top.....25c
<b>307</b> 7 prong tube base.....10c	<b>427</b> 7 hole socket top.....35c
<b>307A</b> Small 7 tube base.....10c	<b>427A</b> Small 7 socket top.....35c

If you would rather have a specially designed plug section which fits into the closely shielded sockets and allows for taking off leads without shorting to the chassis, use these, which come complete with assembly screw and nut:

<b>934B</b> 4 prong plug section 25c	<b>937B</b> 7 prong plug section 25c
<b>935B</b> 5 prong plug section 25c	<b>937BA</b> Small 7 plug section 25c
<b>936B</b> 6 prong plug section 25c	

Send for free catalog sheets showing all kinds of sockets, plugs, connectors, coil forms, etc.

Send a dime for the Na-Aid Adapter Data Sheets showing diagrams of over 300 different adapters for every purpose—descriptions, uses and directions are given on adapters for pickups, microphones, output meters, tone controls, short wave converters, tube checkers, set analyzers, etc., or directions for modernizing obsolete set analyzers, new tube-prong connections, etc.

Ask for information on how to test the 25 and 30 volt tubes with any tube checker.

**Servicemen's Discount**.....35%  
On orders amounting to \$10.00 List.....40%

**ALDEN PRODUCTS CO.**  
Dept. R-6 715 Center St.  
BROCKTON, MASS.

(7) In the event a spark coil and switch are integral and mounted upon the dash or in the driver's compartment, it is advisable to use shielded secondary ignition cable for the secondary lead from the coil to the distributor head. The shielding on this lead should be grounded at the point where it goes through the bulkhead or fire-wall and if possible at each end.

(8) In the event the radio set is mounted in the motor compartment adjacent to the coil, the above recommendation is suggested also.

(9) It is recommended that the coil itself be placed as close to the distributor as possible and as far away from the bulkhead or fire-wall as permissible in so far as the magnetic field set-up by the coil's flux, many times is the cause of considerable interference.

## REPORT OF RMA SUB-COMMITTEE ON ANTENNAS

Detroit, Mich., January 19th, 1933

At the time this Committee was appointed, the problem assigned to it, was to determine commercial means of standard and production tests of automobile antennas during the process of manufacturing.

Complete reports have not been received from the Members of this Committee, but the following suggestions have been received, which will be covered in further detail in a later report.

(1) A test should be made for capacity of the antenna. This is mainly a design test, as after a definite antenna is once specified, the capacity would vary only a small amount. The recommended minimum capacity for cars with rigid tops is 200 to 400 micro-microfarads, and for cars with demountable tops, 100 micro-microfarads. This test would normally be made with a portable capacity bridge.

(2) A test should be made for resistance of the antenna. Due to the fact that in the manufacture of a car, this will probably vary over considerable limits, if a very close inspection is not maintained, it is desirable to make this a 100% production test, as this will, at the same time, indicate any grounds in the antenna system. This test should, of course, be made before the top cover is attached to the car, in order that any defects found can be readily remedied at a minimum of expense. A 500-volt megger is suggested.

(3) It is possible to combine both the capacity and resistance test mentioned above into a single test, which would indicate the resistance of the antenna at radio frequency. A suggested circuit for this radio frequency test will be submitted in the next report.

Inasmuch as the members of various organizations from whom communications have been received on antennas, have desired to make further comment on the points covered in Section VI. of the Minutes of our Meeting of September 16, 1932, a further report of this Committee will include comments on these items if it is the desire of the Members present.

## Report of Sub-Committee on Automobile Radio Standardization as Outlined in Sections One B-C and Two A-B, of the RMA Meeting of July 28, 1932

The general opinion concerning the mounting locations and associated dimensions allocated by the motor car manufacturers for the installation of automobile radio is that they cannot be definitely established at this time on account of the rapid changes of design at this stage of the industry. Consequently each manufacturer will have to work out his own arrangements in order to have the most practical installation available for each particular body and chassis design. Therefore, we would recommend that the suggestions as outlined by the RMA Committee remain on record until more definite and permanent dimensions can be established by the RMA and SAE.

## The latest addition to the RADIO-CRAFT Library Series—

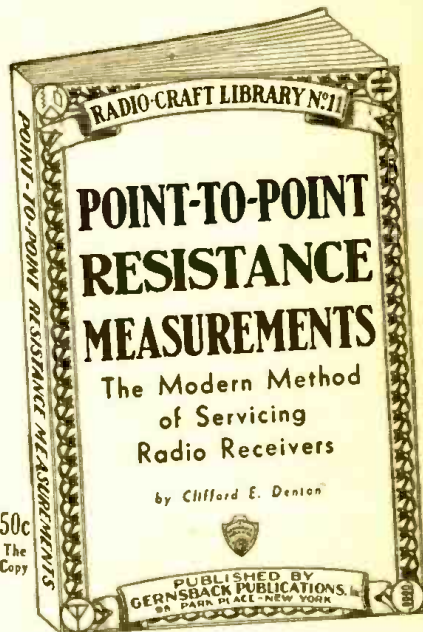

## —ANOTHER VALUABLE BOOK FOR SERVICE MEN

Of the difficult problems which Service Men face today when repairing receivers, the greatest is that of replacing proper resistance values in sets. This task becomes even more difficult when the values of resistors are unknown; and manufacturers of many standard sets do not pass this information to Service Men.

In this new book, "RESISTANCE MEASUREMENTS" radio men will find the information needed to quickly place a receiver in normal operating condition. This book cuts in half, the time usually required to adjust the average set. Sufficient space has been devoted to the elementary problems and the theory of electricity as it is applied to resistance measurements so that the Service Man will have a comprehensive idea as to how to overcome this problem.

Below you will find a partial list of the contents which will appear in this new book... prepared by one of radio's foremost service writers, Clifford E. Denton.

Partial Contents of  
**POINT-TO-POINT RESISTANCE MEASUREMENTS**

**CHAPTER 1—INTRODUCTION.** Advantages of Resistance Measurement Method of Servicing for Radio Work.

**CHAPTER 2—Basic Principles.**

**CHAPTER 3—Methods of Resistance Measurement.**

**CHAPTER 4—Resistors in Radio Receivers and Amplifiers.**

**CHAPTER 5—Point to Point Resistance Measurements in Typical Radio Set using Ohmmeter.**

**CHAPTER 6—Resistance Measurements using Modern Tester.**

**CHAPTER 7—Routine Testing where Circuit Diagram is Available and where Resistances are Known.**

**CHAPTER 8—Routine Testing where Circuit Diagram is Not Available and where Resistances Are Unknown.**

**CHAPTER 9—The Relation of Voltage Testing Methods to Resistance Measurement.**

**CHAPTER 10—APPENDIX.** Resistance Charts, etc.

**64 PAGES — 6x9 INCHES  
OVER 100 ILLUSTRATIONS**

Mail Coupon Today!

GERNSBACK PUBLICATIONS, Inc. RC-633  
96-98 Park Place, New York, N. Y.

Enclosed you will find my remittance of Fifty Cents (check, stamps or money order accepted), for which you are to send me One Copy of POINT-TO-POINT RESISTANCE MEASUREMENTS, by Denton.

Name.....  
Address.....  
City..... State.....

See the July issue of Radio Craft for complete construction details of an automotive receiver.



# BOYS! THROW YOUR VOICE

Into a trunk, under the bed or anywhere. Lots of fun fooling teacher, policeman or friends.



## THE VENTRILO

a little instrument, fits in the mouth out of sight, used with instructions for making - dry batteries, dynamos, electric motors, telegraph apparatus, telephones, electric lights, electric door bells, alarms, electric engine, rheostat, mail box alarm, electro-magnets, automatic incandescent flash, electric shocking machine, electric telegraph apparatus, electric coil, etc. light, clock reverser, etc., etc. Tells all about electric wiring, static electricity, magnets and magnetism, conductors and insulators, electrostatic induction, electroscopes, electrolysis, Leyden jar, dynamic electricity, the voltaic cell, electromagnets, electrolysis, electro-plating, electrotyping, how to build a radio for a few cents, etc. 62 pages. 100 Illustrations. 10c postpaid. J. JOHNSON SMITH & CO., Dept. 946, Racine, Wis.

# BLANK CARTRIDGE PISTOL

Protection against Burglars, Tramps & Dogs



Prices  
50c  
\$1.00

Shipped by Express only.

Well made and effective; modelled on latest type of Revolver apparatus. One is enough to scare a burglar. When loaded it may be as effective as a real revolver without danger to life. It takes standard 22 Cal. Cartridges obtainable every where. Price 50c, superior quality, \$1.00. Blank Cartridges, 50c per 100. Holster (Cowboy type) for Blank Cartridge Pistol, 50c. Shipped by Express only.

# MAKE YOUR OWN RADIO RECEIVING SET



Enjoy the comfort, base ball game, market reports, latest news, etc. This book is a righted book of EFFICIENT RADIO SETS. Shows how to make and operate inexpensive Radio Sets; the materials for which can be purchased for a mere trifle. Also tells how to build a short-wave Receiver for bringing in foreign stations, police calls, ships at sea, etc. ONLY 15c. postpaid.

# SILENT DEFENDER



Used by police officers, detectives, sheriffs, night watchmen and others as a means of self-protection. Very effective. Easily fits the hand, the fingers being grasped in the four holes. Very useful in an emergency. Made of aluminum they are very light, weighing less than 2 ounces. Handy pocket size always ready for instant use. PRICE 25c each, 2 for 45c postpaid. Catalog 10c.



## THE BUDDY PHONE

A Real Telephone. Works Indoors or Outdoors. Though this is merely a very clever toy, it is quite as serviceable for short distances as the most elaborate apparatus made and it is much less liable to get out of order or to need adjustment; in fact it cannot be rendered inefficient unless roughly handled. No troublesome battery, no intricate "hook-up." Can be put to practical use from one room to another, up or down stairs, around corners, etc. The patented sounding disc transmits and receives the voice perfectly, making it a really practical talking telephone. Set consists of two phones, transmission cord and full instructions. Price only 65c per set postpaid.

# WONDERFUL X-RAY TUBE

A wonderful little instrument producing optical illusions both surprising and startling. With it you can see what is apparently the bones of your fingers; the lead in a lead pencil, the interior opening in a pipe stem, and many other similar illusions. PRICE 10c, 3 for 25c.

# Exploding Matches

More fun than fighting with ordinary matches but explode with a loud bang when lit. 12 matches in a box. PRICE 10c per box, 3 boxes 25c, or 75c per doz. boxes. Not available. Shipped by Express only.

# ITCHING POWDER

This is another good practical joke! The intense discomfort of your victims is thoroughly enjoyable. All that is necessary to start it is to rub a little of the powder on a person's hand and the powder can be relied upon to do the rest. The result is a vigorous scratch, then some more scratch, and still some more. 10c per box, 3 boxes for 25c or 75c per dozen. Shipped by Express.

# ANARCHIST BOMBS

One of these glass vials dropped in a room full of people will cause more consternation than a hamburger cheese. The smell entirely disappears in a short time. 10c per doz. Boxes for 75c per doz. Boxes, or 37.50 per gross. Boxes shipped by Express. Not Prepaid.

# SNEEZING POWDER

Place a very small amount of this powder on the back of your hand and blow it into the air, and watch them sneeze without knowing the reason why! It is most amusing to hear their remarks, as they never suspect the real source, but think they have caught it one from another. Between the laughing and sneezing you yourself will and amuse your guests. For parties, political meetings, car rides, or any place at all where there is a gathering of people, it is the greatest joke out. PRICE 10c, 3 for 25c, 75c per dozen. Shipped by Express. Not Prepaid. Catalog 10c.

# COMICAL MOTTO RINGS

Lots of harmless fun and amusement wearing these rings. Made in platinum (to resemble platinum) with wording on inner band, as illustrated. Price 25c, ea. Postpaid.

# MAGIC MADE EASY 250 MAGIC TRICKS

An excellent little book containing 250 Parlor Tricks, tricks with cards, coins, handkerchiefs, eggs, rings, gloves, etc. So simple that a child can perform them. Profusely illustrated. Sent postpaid to any address for only 10c. 3 copies for 25c postpaid.

# BOY AMATEUR ELECTRICIAN 10c

The HOW and WHY of electricity fully told in simple language that any boy can understand. Scores of plans and instructions for making - dry batteries, dynamos, electric motors, telegraph apparatus, telephones, electric lights, electric door bells, alarms, electric engine, rheostat, mail box alarm, electro-magnets, automatic incandescent flash, electric shocking machine, electric telegraph apparatus, electric coil, etc. light, clock reverser, etc., etc. Tells all about electric wiring, static electricity, magnets and magnetism, conductors and insulators, electrostatic induction, electroscopes, electrolysis, Leyden jar, dynamic electricity, the voltaic cell, electromagnets, electrolysis, electro-plating, electrotyping, how to build a radio for a few cents, etc. 62 pages. 100 Illustrations. 10c postpaid. J. JOHNSON SMITH & CO., Dept. 946, Racine, Wis.

# BIG ENTERTAINER

180 Jokes and Riddles. 34 Magic Tricks, 54 Parlor Games, 73 Toasts, 15 Tricks with Cards, 60 Money-making Secrets, 10 Funny Readings, 3 Monologues, 4 Fairy Tales, 21 Puzzles and Problems, 5 Comic Recitations, Dominoes, Fox and Geese, 9 Men Morris, Spanish Prison Puzzle, Game of Anagrams, etc. All for 15c postpaid.

# ONLY 10c Per Pair



## Fighting Roosters

With very little practice you can make these miniature models of Game Roosters imitate in the most life-like manner the motions of the FIERCE COCK-FIGHT. Endless amusement. Well made, with real feathers. Pair 10c, 3 prs. 25c. postpaid.

# MIDGET BIBLE

GREAT! Smallest Bible in the World. Size of a postage stamp. 200 Pages. Sold to bring good luck to the owner. A genuine work of art. Must be seen to be appreciated. Make good money selling them to friends, church acquaintances, model 10c, 2 for 40c, 12 for \$1.35, 100 for \$7.50. Also obtainable in Leather Binding, with gold edges. Price 50c each, 3 for \$1.25, \$4.50 per doz. Magnifying Glass for use with Midget Bible 15c.

# SERPENT'S EGGS

Box contains 12 eggs. When lit with a match, each one gradually hatches itself into a snake several feet long, which curls and twists about in a most life-like manner. Price per box, 10c postpaid, 3 for 25c.

# STAGE MONEY

With a bunch of these bills, it is easy for each person of limited means to get rich and prosperous by flashing a roll of these bills a few times. The key to your future time and peeling off a genuine bill or two from the outside of the roll the effect created will be found to be all that can be desired. Prices, postpaid: 40 Bills 20c, 120 for 50c, or \$3.50 thousand postpaid.

# TELL YOUR OWN FORTUNE

With the aid of this dream book and fortune-teller. The key to your future. You will be lucky in love! Successful in business! You are wealthy! Complete with dictionary of dreams with descriptions and correct interpretations, with lucky numbers, fortunate days, oracles, divination, palmistry, etc. Price 10c p. pd.

# FORTUNE TELLING BY CARDS

64 page book tells how. Gives the meaning of each and every card, how to deal and lay them out. Everything explained in simple language. 10c postpaid.

# DREAM BOOK

Complete with dictionary of dreams with descriptions and correct interpretations, with lucky numbers, fortunate days, oracles, divination, palmistry, etc. Price 10c p. pd.

# LATEST CATALOG

A copy of our NEW CATALOG mailed on receipt of 10c, or the De Luxe Edition with cloth binding 25c. Bigger and better than ever. Only book of its kind in existence. Nearly 800 pages of all the latest tricks in magic, the newest novelties, parties, games, sporting goods, rubber stamps, unusual and interesting books, curiosities in seeds and plants, etc., unobtainable elsewhere. Remit by Cash, Money Order, Check or Express. U. S. Postage, for all articles listed above. Cash money, stamps and Postal Notes accepted if 20% added for Exchange.

# LOOK 35c LOOK WONDERFUL INSTRUMENT

Greatest thing yet. Nine separate articles in one. Everybody delighted with it. Odd, Curious and interesting. Lots of pleasure as well as very useful. It is a double Microscope for examining the wonders of nature. It is also an Opera Glass, a Telescope, a Burning Lens, a Reading Glass, a Telescope, a Compass, a pocket Mirror, and a Laryngoscope - for examining eye, ear, nose and throat. It is worth all the cost to locate even one painful cluster in the eye. Fold flat and fits the pocket. Something you need now. Don't miss it. Sent by mail. Only 35c or 3 for \$1.

# Electric Telegraph Set 15c

Here you are boys! A private electric telegraph set of your own for 15c! Lots of fun sending messages to your friends. Get two sets, hook them up as shown in the directions, for two-way messages for sending and receiving. No trouble at all to operate with the simple instructions that accompany each set. Operates on any standard dry battery obtainable everywhere. With this outfit you can learn to transmit and receive messages by the Morse International Code, and in a very short time become an expert operator. Mounted on wooden base measuring 4 1/2 inches. First class construction throughout, complete with key, sounder, magnet, miniature Western Union flasher, packed in a neat box with full illustrated instructions - ALL FOR 15c (without battery) postpaid.



# CRYSTAL RADIO RECEIVER \$1.00

Say what you will about Electrical and Battery Sets, a CRYSTAL set has them all beat for simplicity and clearness of tone. There is absolutely no noise and no distortion - no batteries to buy - no tubes to wear out - no maintenance expense whatsoever. Cost nothing to operate and will last indefinitely. Reception is loud and clear. This Receiver is guaranteed to work equal to the most expensive Crystal set you can buy. Has a receiving range of over 25 miles, or under favorable conditions up to 100 miles. Constructed of the finest materials throughout, including super-sensitive crystal, assurance of long life. Everything all complete - nothing more to buy. \$2.95 postpaid. Johnson Smith & Co., Dept. 946, Racine, Wis.

# AIR PISTOLS

Just what you've always wanted. A powerful high grade Air Pistol, shaped like an Automatic, pocket size. Fires B. B. shot obtainable anywhere. Very powerful yet perfectly safe for boys to handle. Two styles - Single Shot Pistol or Repeater. The Repeater fires 10 shots in one loading. The Single Shot Pistol shoots Air Rifle Darts in 100 ft. B. B. shot. Well made and durable; all metal diction to B. B. shot. Weights about 10 ounces. Better than an air Gun. Shipped by Express only. PRICES: Single Shot Pistol... \$2.50 100-Shot Repeating Pistol... \$5.00

# STAR TOY MAKER

Created by a boy's book written. Tells how to make a Pinhole Camera, a Camera, a Railroad, a Telephone, a Boomerang, Telegraph Instrument, Box Kites, Talking Machines, Microscope, Electric Motor, Electric Door Bell, Water Wheel, Paddle Boat, a Dog, a Dog sled, Bird House, Rabbit Yard, etc. 64 pages. 160 Illustrations. PRICE 10c.

# BOY'S OWN TOYMAKER

A new book. Tells how to make chemical toys, electrical toys, mechanical toys, paper toys, cardboard toys, boats, traps, etc. 200 Illustrations. Price 25c postpaid.

# FUN WITH MAGNETS

20 novel and amusing experiments in MAGNETISM that you can perform with the aid of an ordinary magnet. Includes making magnets, spinning magnets, nail and ball magnets, making a motor, magnetic billiard balls, many other stunts. Also interesting information about lodestone, magnetism, electricity, etc. 10c.

# BOOK ON BOATS

How to build boats and sailing boats. Everything about boats explained in plain terms so anyone can understand. Illustrated. 10c p. pd.

# 5-MINUTE HARMONICA COURSE

Contains all the latest and best songs to play, to use the tongue, tremolo, fully illustrated. Price 15c postpaid.

# 125 CARD TRICKS and sleight of hand

Contains all the latest and best card tricks as performed by celebrated magicians, with exposure of card tricks used by professional gamblers. Price 25c postpaid.

# PERFORMING SKELETON

A jointed figure of a skeleton 14 in. in height. Will dance to music and perform various gyrations and movements while the operator may perform any of the following stunts. Price 10c, 3 for 25c. pd.



# Radio-Craft **FREE** BOOKLET SERVICE

## READERS' BUREAU

On this page are listed manufacturers' catalogs and booklets, chosen because they are of interest to readers of RADIO-CRAFT. You can obtain copies FREE by using the coupon below.

101. WESTERN ELECTRIC TUBES. A want long-felt among amateurs in radio telephony is filled by a catalogue just issued by the Western Electric Company. The catalogue covers types of vacuum tubes produced by this manufacturer for use only by licensed amateurs in radio telephone transmitting equipments. In all, 27 tubes are described, running from the smallest or so-called "peanut" tube to the 276A, which has a maximum plate dissipation of 100 watts.

Two pages in the catalogue are devoted to the information on each tube. The information consists of a statement of the uses of the tubes, a table of electrical characteristics; a line drawing showing the shape of the tube, its internal structure and its outside dimensions; a diagram indicating where the various leads appear in the base prongs or other connections and the code numbers of the sockets with which the tube may be used. In short, all data required by the amateur for designing his radio telephone circuits equipment are presented.

6. CLAROSTAT CONTROL HANDBOOK. A large 32-page book containing detailed specifications of volume controls, attenuators, constant-impedance controls, phonograph pickup faders, tone controls, line ballasts, rheostats, potentiometers and fixed resistors of various kinds, together with valuable circuit-design data. Contains many diagrams and charts, and a guide of replacement volume and tone controls for many commercial receivers. Clarostat Manufacturing Company, Inc.

6. MEASURING RESISTANCE BY THE DEFLECTION METHOD. The conventional method for the measurement of resistance involves the use of the Wheatstone bridge, a costly piece of apparatus. However, there are other methods which provide a fair degree of accuracy, enough for all practical purposes. The least expensive is the deflection method, which makes use of popularly priced milliammeters and fixed resistors. This bulletin describes the method completely, and should be very useful to Service Men and experimenters with limited meter equipment. Shallcross Manufacturing Company.

11. SUPREME INSTRUMENTS. Contains lengthy descriptions of the Supreme service instruments, including the AAA1 Diagonometer, which is five instruments in one, the model 90 analyzer, the model 40 tube tester and the models 60 and 70 oscillators. Interesting to the Service Man because it tells how his work is facilitated by ingeniously-designed test equipment that indicates the condition of an entire set in a few minutes. New test apparatus to take care of the new tubes is also described. Supreme Instrument Corporation.

19. A BAPTISM OF FIRE. Centralab fixed resistors are made by forcing a carefully calibrated resistance material through a plastic ceramic material, and then baking both under terrific heat. This booklet describes the manufacturing

Process in detail, and lists the advantages claimed for fixed resistors of this type. It is interestingly written and illustrated, and makes good reading. Central Radio Laboratories, Inc.

21. READRITE RADIO INSTRUMENTS. This sixteen-page pamphlet contains some valuable hints on the testing of electrolytic condensers, as well as descriptions of the full line of popular-priced Readrite instruments. Worth having. Readrite Meter Works.

22. HOW TO TEST PENTODES. This is a reprint of an article of the same name that appeared in the September, 1931, number of RADIO-CRAFT, accompanied by descriptive matter on the adapters specified for the purpose. If you missed the original article study the reprint; it contains much useful data for owners of testers or analyzers not already equipped to test pentodes. Alden Manufacturing Company.

76. THE COAST-TO-COAST "BROADCAST." The "Broadcast" is the Fall 1932 edition of a 100-page mail order catalog that is a veritable encyclopedia. Its listings are very varied, and run from soldering lugs to complete 100-watt public address amplifiers. Every article is well illustrated and described for the benefit of radio dealers and Service Men, for whom the volume is specifically intended.

A large amount of space is also given to replacement power transformers, condensers and resistors for ordinary service work. This catalog is well prepared and is worth saving. Coast-to-Coast Radio Corporation.

81. I. R. C. RESISTOR CATALOG. This sixteen-page catalog describes a very complete line of fixed resistors for radio purposes. It includes full performance characteristics, so that a Service Man or an experimenter with a particular requirement in mind can select exactly the right unit for his purpose. A section in the back contains valuable data on the conversion of milliammeters into ohmmeters and voltmeters, and on the extension of voltmeter and ammeter ranges. This catalog is well worth saving. International Resistance Company.

94. ELECTRAD PRODUCTS. The newest and latest catalog of Electrad products contains twelve pages and lists many types of fixed and variable resistors and five different kinds of amplifiers for public address purposes. The popular Truvolt resistors have been improved by the addition of insulating shields and heat radiating covers, and a number of new sizes have been added to the line. The catalog also contains some valuable data on the application of resistors to radio receivers, transmitters, amplifiers and sound systems, and suggestions on how to compute the value of resistors. A handy and useful catalog. Electrad, Inc.

96. TOBE FILTERIZER AND CONDENSERS. The Tobe Deutschmann company is now catering to the Service Man with an extensive line of filter, by-pass and line condensers and radio noise eliminators. Their latest catalog, describing the complete line, has just come off the press. A full page is given to the new "Filterizer" noise eliminating antenna system, an item of particular interest to Service Men because of the money-making opportunities it offers. Tobe Deutschmann Corporation.

97. ARCO TUBE BULLETIN. A descriptive folder giving full technical characteristics on the complete line of Arco radio receiving and transmitting tubes, photo-electric cells, television lamps, hot and cold cathode tubes, cathode ray tubes, rectifiers and charger bulbs. This can be posted for easy reference. Arco Tube Company.

98. HOW TO USE NOISE REDUCING ANTENNA SYSTEM ON BROADCAST WAVES AND SHORT WAVES is the title of the latest booklet on this important subject. In addition to covering the theory, the practical application of the various noise-reducing systems available for broadcast and short wave use, is described also. Lynch Mfg. Co.

99. AMPERITE CHART. Service Men will find this chart very valuable, as it shows the correct Amperite line voltage regulator to use with any of several hundred different broadcast receivers. An accompanying pamphlet explains how overloaded condensers and resistors may be the cause of crackling noises and poor reception. Amperite Corporation.

100. WHOLESALE RADIO SERVICE CATALOG. The new Spring 1933 Wholesale Radio catalog contains 152 pages, and is probably the largest mail order catalog of its kind in print. It is exceptionally complete, and includes everything from soldering lugs to all-wave receivers. It is of value to dealers, Service Men and experimenters for reference and ordering purposes. Wholesale Radio Service Co. Inc.

## CLASSIFIED ADVERTISEMENTS

Advertisements in this section are inserted at the cost of ten cents per word for each insertion—name, initials and address each count as one word. Cash should accompany all classified advertisements unless placed by a recognized advertising agency. No less than ten words are accepted. Advertising for the July 1933 issue should be received not later than May 9th.

### DOGS

BEAUTIFUL Registered bull pups, \$15. Bull-dogs. 501-RC, Rockwood, Dallas, Texas.

### INSTRUCTION

CANADA'S Oldest and best equipped radio school offers complete course covering Radio, Television, Sound Amplification, etc. Approved by leading radio manufacturers. No duty or exchange to pay. Radio College of Canada, Limited, 310 Yonge St., Toronto.

GOVERNMENT Jobs. \$105.00-\$225.00 month. Men—women, 18-50. Qualify for future vacancies. Common education. 25 coached FREE. Write immediately. Franklin Institute, Dept. K77, Rochester, N. Y.

### RADIO

MAGNETIC Speakers rewound and adjusted, \$1.25. Radio Service, Florida, Indiana.

GUARANTEED "Pocket Radio," \$2.00. Catalog, 10c. Neil Tasker, Shamokin, Pa.

TRANSFORMERS REWOUND, varnished, baked, guaranteed, reasonable cost. SPEAKER REPAIRING, magnetic \$2.00-\$2.50; dynamic, voice coils, fields, etc., reasonable charges. Clark Bros. Radio Co., Albia, Iowa.

TRANSFORMERS AND SPEAKER FIELD COILS rewound or made to order. Transformer and complete instructions on rejuvenating of AC tubes \$4.00 postpaid. 5 hours service. Pemberton Laboratories, 921 Parkview, Fort Wayne, Indiana.

1500 MILE Crystal circuit, 6 others, including new selective circuit operating speaker. Blueprint, 25c coin. Modern Radiolabs, 1508 23rd Avenue, Oakland, Calif.

BLUEPRINTS Of latest T.R.F. circuit, A. C. operated receiver. Pure tone model, long range, newest tubes, 25c. Barreto Radio Laboratories, 13 Peck Slip, New York City.

ULTRA-MODERN SUPER. All parts for this famous set mounted on a cadmium-plated chassis and partly wired, for sale. Only manufactured parts used; everything in excellent shape. Set described in October issue of this magazine. Price, \$20.00. First money takes it—a real buy. Z. Martin, 415 Lefferts Ave., Brooklyn, New York.

## Power Generator

FOR SHORT WAVE BROADCASTING. Reg. Price Was \$75 U. S. Gov. power generator for radio transmitting made by Westinghouse. Ideal for Amateur Broadcasting. Limited quantity purchased from U. S. Gov. Signal Corps. 900 cycles. 200 watts. 110 Volt R.P.M. 3500. Can be connected direct, belt driven or wind propelled for Aeroplanes. Guaranteed new and perfect. Worth \$75.00, but while they last, only \$4.95, plus shipping charges. Shipping weight 13 lbs. Send check or money order.

While They Last!  
\$4.95

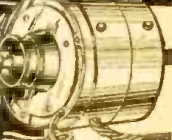

WELLWORTH TRADING CO.  
148 E. Superior St., Chicago, Ill.

Wellworth Trading Co.  
148 E. Superior St.,  
Chicago, Ill.

Enclosed find \$4.95 for which send me express collect your Power Generator as described in your ad.

Name .....

Address .....

City .....

State .....

RADIO-CRAFT 5-101  
Readers Bureau  
96-98 Park Place, New York, N. Y.

Please send me free of charge the following booklets indicated by numbers in the published list above:

No. ....

Name .....

Address .....

City ..... State .....

(Please check the following)

- I am  
 (1) Service Man  (2) Experimenter  
 (3) Dealer  (4) Jobber  
 (5) Radio Engineer  
 (6) Licensed Amateur  
 (7) Professional or Amateur Set Builder

This coupon will not be honored unless you check off your classification above.





# TWO STAGE 250 SUPER-POWER AUDITORIUM-SOUND TRUCK and PUBLIC-ADDRESS-AMPLIFIERS

FACTORY WIRED  
READY FOR  
IMMEDIATE  
USE



Excellent  
Adapted for  
**RADIO TUNER**  
**PHONO PICKUP**  
**MICROPHONE**  
AMPLIFICATION

**\$8.95**  
TUBES REQUIRED  
1-226, 1-250,  
2-281.

BRAND  
NEW!

**FULLY GUARANTEED!**

This Amplifier is the original AP-736 Model (which was furnished with Victor Electroas selling as high as \$1,000.00). Due to the "quick heater" action of the 1st A.F. Tube, and in fact of all the tubes in the \$8.95 Model, that amplifier is especially valuable for use in INTER-OFFICE COMMUNICATION SYSTEMS, or wherever it is necessary to operate an amplifier "the moment" it is turned on! The two stage \$8.95 model employs 1-226 input tube (and associated high and low impedance input transformers), which is audio transformer coupled into a 250 Stage and utilizes FULL WAVE 2-281 Rectifiers. An output transformer furnished and utilizes IMPROVED \$19.50 model comprises the following: A UNIVERSAL INPUT VOLUME CONTROL is in the grid circuit of the first "pre-amplifier" 56 tube, the output of which is resistance coupled into a second 56 A.F. Stage, which in turn is PUSH-PULL TRANSFORMER COUPLED TO TWO SUPER-POWER 250 TUBES! Its enormous output of 13 watts is DISTORTION-FREE and amazingly faithful in its sheer realism of fidelity. By virtue of its employment of THREE HIGH GAIN A.F. STAGES, microphone and phono pick-up amplification is enormous and makes this amplifier accordingly extremely valuable. (Its D.B. Gain is rated at 92 D.B.) The input terminals may be connected to any secondary winding of any input transformer (generally contained in control boards) or to a radio tuner output plate circuit, high impedance phono pick-up, etc. Both the \$8.95 and \$19.50 models furnish D.C. Field Current Excitation to from One to Four Dynamic Speakers. Connection diagrams are furnished showing how to connect the field coils of 1-2500 ohm, 1 or

2-1000 ohm, or 4-2500 ohm (110 Volt D.C. Type) DYNAMIC SPEAKERS. Note that if only one Speaker will be used, then no output transformer is required, as our Speakers are equipped with a suitable matching transformer. Constructed upon a ¼ in. thick malleable iron chassis of great strength, handsomely Duco sprayed, measuring 17½ in. long, 12½ in. wide and 7½ in. tall over-all. An imposing idea of its contents can be gleaned by its weight of fully 88 lbs.! The power transformer is of heavy-duty design, and will function practically indefinitely, even over continuous operating periods. The filter condenser system is also practically foolproof, due to some of its units being rated as high as 1,500 volts! Perfect impregnation of vital components makes same impervious to the ravages of both extremes of climatic changes... even ideal for use in the tropics! A clever automatic and fool-proof switching arrangement protects the amplifier should it be turned on when a speaker is temporarily disconnected. Another switch permits selection of 90 to 105 Volt or 105 to 120 Volt A.C. operation. Receptacles are provided for an A.C. Line Cord Male Plug and for a convenient speaker field current outlet. All connection terminals are clearly engraved on a readily accessible bakelite terminal strip. PRODUCES GIANTIC DISTORTION-FREE VOLUME. REMARKABLE LIFE-LIKE REPRODUCTION! You will be immensely thrilled by the almost uncanny reproducing qualities of these amazingly powerful amplifiers—either using it as a microphone, phonograph or Radio Tuner amplifier! We want you to expect the most, for, you will not be disappointed!

## TWO STAGE SUPER-POWER 250 MODEL

TWO STAGE AMPLIFIER Less Tubes and Speaker Ready For Immediate Operation **\$8.95**

TWO STAGE AMPLIFIER With Four RCA Tubes and choice of one Wright De Coster or Jensen Dynamic Speaker **\$17.50**

TWO STAGE AMPLIFIER Equipped With FOUR GENUINE RCA TUBES (1-226, 1-250, 2-281) **\$12.75**

TWO STAGE AMPLIFIER With Four RCA Tubes and choice of two Wright De Coster or Jensen Dynamic Speakers **\$22.50**

## Three Stage 250 Push-Pull 13 Watt Model

3 STAGE AMPLIFIER Less Tubes and Speaker Ready For Immediate Operation **\$19.50**

3 STAGE AMPLIFIER, with GENUINE RCA tubes, and including your choice of one Wright De Coster or Jensen Dynamic Speaker **\$33.50**

3 STAGE AMPLIFIER Equipped With SIX GENUINE RCA TUBES (2-56, 2-250, 2-281) **\$26.50**

3 STAGE AMPLIFIER, with six Genuine RCA tubes and including your choice of TWO Wright De Coster or Jensen Dynamic Speakers **\$38.50**

Special Output Transformer—Matches voice coils of from 2 to 16 Dynamic Speakers. Rating: 500 ohms 15-7½-3¼ ohms, \$3.95

**EXCELLENTLY ADAPTED FOR AMPLIFICATION OF**

MICROPHONE

PHONOGRAPH

INTER-OFFICE COMMUNICATION

RADIO TUNER AMPLIFICATION

Hum Free Reproduction

Fool Proof Operation

Distortion Free Results

Can furnish D.C. FIELD CURRENT To From **ONE-TO-FOUR** 1000 or 2,500 OHM D.C. DYNAMIC SPEAKERS

TUBES EMPLOYED 1-226, 1-250, 2-281

**SCREEN GRID TUBE PROVIDES ENORMOUS PRE-AMPLIFICATION**

**TWO STAGE 250 PUBLIC-ADDRESS AMPLIFIER**

HIGH GAIN

OPERATES THE MOMENT SWITCH IS TURNED ON

**UNDISTORTED OUTPUT 5 WATTS**

AMPLIFIER LESS TUBES AND SPEAKER READY FOR IMMEDIATE OPERATION **\$13.95**

**COMPLETE INSTALLATION**

AMPLIFIER AND 4 RCA TUBES ONE DOUBLE BUTTON MICROPHONE ONE ADJUSTABLE PHONO STAGE ONE TUNER INPUT CONTROL BOX ONE WRIGHT-DE-COSTER SPEAKER **\$39.95**

**AMPLIFIER**

WITH 4 RCA TUBES 1-226, 1-250, 2-281 WRIGHT-DE-COSTER DYNAMIC SPEAKER, 16 25 ADDITIONAL **\$18.95**

**Allen Hough Synchronous Phono. Motor**

Only 1¼ in. thick. Re- volves exact speed of 78 R.P.M. despite any volt- age variation in 110 volt. 60 cycle A.C. line. 10- inch turn-table included. **\$165**

Nationally Advertised  
**Phono. Pick Up**

Extremely sen- sitive. Equipped with volume control.

**EXTRA SPECIAL \$5.95**

**ONE DOLLAR SERIES**

A ¼ in. square core of high Silicon steel. Rigid steel channel strap. The 6 inch leads are made of heavily insulated wire. The coils are scientifi- cally treated to be impervious to all at- mospheres—a very valuable and neces- sary feature. The overall measurements of all the units are 3½ in. long, 2 in. wide, 2 in. tall. There is no better quality trans- former available!

**Westinghouse**

**Audio and Input Push-Pull Transformers**

5 to 1 Audio  
3 to 1 Audio  
2 to 1 Audio  
Input Push-Pull  
Input Push-Pull with Split Secondary  
Inter-Stage Push-Pull

**Output Transformers**

From 1-171, 245, 250, etc., to 8-15 ohms Voice Coil  
From 1-247, 59, 233, 238, etc., to 8-15 ohms Voice Coil  
From 2-171, 245, 250, etc., to 8-15 ohms Voice Coil

**Audio Transformers**

From 2-247, 59, 233, 238, etc., to 8-15 ohms Voice Coil  
**Phono-Pickup**

**Inputs**  
Low Impedance  
High Impedance

**Microphone**

**Inputs**  
Single Button—200 ohm  
Double "Button"—200 ohm Line

**Transformers**  
500 ohm line to Grid Plate to 500 ohm Line  
Control Box to 500 ohm Line  
**Filter Choke**  
30 Henry, 200 ohms. 150 mA

**Your Choice \$1.00 Each**

Nationally Advertised  
**200 Ohm Double Button Microphone**

Remarkably sensitive— covers wide fre- quency range. Ac- tual worth. \$25.00! **Big Value \$5.25**

"Mike" Desk Stand and Ring, \$3.25  
45-72 M. Adjustable "Mike" Stand, \$6.75

**Universal Combination**  
Phono-Microphone and Radio Tuner Input Matching Transformer

Permits universal input applica- tions from one transformer, Uni- versal Phono-Pickup, (Both 200 and 500 ohms, as well as 3000 ohms) and Microphone (Single or Double But- ton 200 ohms) Transformers, **\$1.95**

All offers are F. O. B. New York, and subject to prior sale. Terms: A deposit of 20% is required with every order. Balance may be paid on delivery. Or, deduct 2% if full amount is sent with order.

**GREN PARK CO., Dept. RC 245 GREENWICH STREET, NEW YORK, N. Y.**



2

# USEFUL RADIO BOOKS WHICH EVERY EXPERIMENTER NEEDS IN HIS LIBRARY

There is not a radio man in the field, experimenter, service man or dealer, who will not want to read these two books. Right up to the minute with outstanding developments in short-wave radio—new methods and apparatus for quickly learning how to become a practical radio operator. Each book is authoritative, completely illustrated and not too highly technical. The text is easily and quickly grasped.

## How to Become An Amateur Radio Operator

We chose Lieut. Myron F. Eddy to write this book because his long years of experience in the amateur field have made him pre-eminent in this line. For many years he was instructor of radio telegraphy at the R.C.A. Institutes. He is a member of the I.R.E. (Institute of Radio Engineers), also the Veteran Wireless Operators' Association. If you intend to become a licensed code operator. If you wish to take up phone work eventually. If you wish to prepare yourself for this important subject—this is the book you must get.

### Partial List of Contents

Ways of learning the code. A system of sending and receiving with necessary drill words is supplied so that you may work with approved methods. Concise, authoritative definitions of radio terms, units and laws, brief descriptions of commonly used pieces of radio equipment. This chapter gives the working terminology of the radio operator. Graphic symbols are used to indicate the various parts of the radio. General radio theory particularly as it applies to the beginner. The electron theory is briefly given, then waves—their creation, propagation and reception. Fundamental laws of electric circuits, particularly those used in radio, are explained next and typical basic circuits are analyzed. Descriptions of modern receivers that are being used with success by amateurs. You are told how to build and operate these sets. Amateur transmitters. Diagrams with specifications are furnished so construction is made easy. Power equipment that may be used with transmitters and receivers. Rectifiers, filters, batteries, etc. Regulations that apply to amateur operators; the International "Q" signals, etc.

## How to Build and Operate Short Wave Receivers

is the best and most up-to-date book on the subject. It is edited and prepared by the editors of SHORT-WAVE CRAFT, and contains a wealth of material on the building and operation, not only of typical short-wave receivers, but short wave converters as well. Dozens of short-wave sets are found in this book, which contains hundreds of illustrations; actual photographs of sets built, hook-ups and diagrams galore. The book comes with a heavy colored cover, and is printed throughout on first-class paper. No expense has been spared to make this the outstanding volume of its kind. The book measures 7 1/2 x 10 inches. This book is sold only at such a ridiculously low price because it is our aim to put this valuable work into the hands of every short-wave enthusiast. We know that if you are at all interested in short waves you will not wish to do without this book. It is a most important and timely new radio publication.

**Each Book Contains Over 150 Illustrations  
72 Pages 7 x 10 Inches Not Sold on Newsstands**

SHORT WAVE CRAFT, 96-98 Park Place, New York, N. Y.



**50¢ EACH**

**SHORT WAVE CRAFT**  
Dept. RC-6,  
96-98 Park Place,  
New York, N. Y.  
Gentlemen: I enclose herewith \$ for which please send me, prepaid a copy of the book checked.  
( ) **HOW TO BUILD AND OPERATE SHORT-WAVE RECEIVERS—50c.**  
( ) **HOW TO BECOME AN AMATEUR RADIO OPERATOR—50c.**  
Send money order, check, cash or new U. S. stamps. Register letter if it contains stamps or currency.  
Name \_\_\_\_\_  
Address \_\_\_\_\_  
City \_\_\_\_\_ State \_\_\_\_\_

## REFRIGERATORS!

### SERVICE ELECTRIC

In your community there are dozens of electric refrigerators to be serviced. Many need immediate repairs which can be made quickly, with little expense—and which you can repair with the aid of this authoritative Refrigeration Service Manual. Make many extra dollars, together with other repair work. Electric refrigeration servicing is a well-paying business—start in your spare time—before long you will devote full time to it. One or two jobs pay the small cost of the OFFICIAL REFRIGERATION SERVICE MANUAL.

**96 Pages of New Data Have Been Added to the OFFICIAL REFRIGERATION SERVICE MANUAL**

To bring this useful service manual right up-to-date, Mr. L. F. Wright, the editor of the OFFICIAL REFRIGERATION SERVICE MANUAL, has added a wealth of material on new electric refrigerators, and older models as well. An usual every refrigerator has been accurately described from the viewpoint of servicing—diagrams to illustrate the essential parts, so simplified that repair can easily be made. The addition of these new pages will not increase the cost of the book to those who order their copy now.

**Here Are Some of The Important Chapters:**

- Introduction to the Refrigeration Servicing Business.
- History of Refrigeration.
- Fundamentals of Refrigeration.
- Description of All Known Types of Refrigeration.
- Motors.
- Trouble Shooting.
- Unit Parts, Valves and Automatic Equipment.
- Makes and Specifications of Units, Manufacturers of Cabinets, Refrigerators and Automatic Equipment and Many Other Important Chapters.

**OVER 1,200 DIAGRAMS  
450 Pages  
Flexible Looseleaf Binder  
Complete Service Data**

**Mail Coupon Today!**

**GERNSBACK PUBLICATIONS, Inc. RC-633**  
96-98 Park Place, New York, N. Y.  
I enclose herewith my remittance for \$5.00 (check, stamps or Money Order accepted) for which you are to send me, postage prepaid, one copy of the OFFICIAL REFRIGERATION SERVICE MANUAL, together with the extra 96 pages of new material at no extra cost.  
Name \_\_\_\_\_  
Address \_\_\_\_\_  
City \_\_\_\_\_ State \_\_\_\_\_

## Here's a book every Radio Man will refer to dozens of times every day—

**A Valuable RADIO BOOK!**

HERE is one radio book that answers every conceivable question on interference. It contains 76 pages, 8 1/2 x 11 inches, chock full with wiring diagrams, drawings and photographs showing where interference originates—how it is distributed, and how to eliminate it. This is a wealth of information needed by every radio listener, dealer and Service Man.

**Send fifty cents in stamps or check for this book.**

**RADIO-CRAFT MAGAZINE**  
96-98 Park Place New York, N. Y.

### Index to Advertisers

<b>A</b>	
Airex Company.....	752
Alan Radio Corp.....	753
Alden Mfg. Co.....	762
Allied Radio Corp.....	759
American Radio Hardware Co.....	754, 750
Aperite Corp.....	750
Arco Tube Company.....	Inside back cover
Autocrat Radio Company.....	756
Automatic Radio Mfg. Co.....	757
<b>B</b>	
Bell Radio Sales Co.....	751
Blan the Radio Man, Inc.....	752
<b>C</b>	
Carter Genemotor Corp.....	750
Central Radio Laboratories.....	750
Clarostat Mfg. Company.....	751
Classified section.....	764
Coast-to-Coast Radio Corp.....	749
Coyne Electrical School.....	705
<b>D</b>	
Deutschmann Corp., Tobe.....	753
Dumont Electric Company.....	758
<b>E</b>	
Electrad, Inc.....	757
<b>F</b>	
Fordson Radio Mfg. Company.....	752
<b>G</b>	
General Mfrs. Radio Service.....	752
General Winding Company.....	750
Grenpark Company.....	765
<b>H</b>	
Hoodwin Company, Chas.....	754
<b>L</b>	
L & L Electric Company.....	632
Lynch Mfg. Company.....	758
<b>M</b>	
Miles Reproducer Company.....	749
Miller, J. H.....	752
<b>N</b>	
National Radio Institute.....	708, 709
<b>O</b>	
Ohio Carbon Company.....	751
<b>P</b>	
Pioneer Gen-E-Motor Corp.....	754
Polk & Co., R. L.....	752
Popular Book Corp.....	766
Postal Radio Corp.....	759
Precision Resistor Company.....	749
Press Guild, Inc.....	761
<b>R</b>	
Radio Chassis, Inc.....	710
Radio City Products Co.....	759
Radio College of Canada, Ltd.....	753
Radio Research Laboratories.....	753
Radio Service & Supply Co.....	759
Radio Trading Company.....	768
Radio Training Association of America.....	753
Radolek Company.....	752
RCA Institutes, Inc.....	752
RCA-Victor Company, Inc.....	Back Cover
Readers' Service Bureau.....	764
Readrite Meter Works.....	751
<b>S</b>	
Scott Radio Laboratories, Inc., E. H.....	707
Shallcross Mfg. Company.....	761
Shure Bros. Company.....	752
Smith & Co., Johnson.....	763
<b>T</b>	
Truman Radio Company.....	750
Try-Mo Radio Co., Inc.....	767
<b>U</b>	
United Scientific Laboratories, Inc.....	756
Universal Microphone Co.....	761
<b>V</b>	
Van Leuven, D. L.....	752
<b>W</b>	
Wellworth Trading Co.....	764
West Side Y. M. C. A.....	750
Weston Electrical Instrument Corp.....	755
Wholesale Radio Service Co.....	761



# POWERTONE

## COMPANIONETTE AUTO RADIO

The Companionette Auto Radio is so compactly designed that it takes up less space in the car than the ordinary speaker which is now installed with other auto radios. The installation is very simple. Only three holes are drilled to mount this set due to the fact that the speaker and chassis are built all in one unit.

### SIMPLE INSTALLATION

Only three connections are required to install the Companionette—one connection to "A" battery, one to "B" battery and the other to the ground. It is also constructed to operate on any "B" battery Eliminator, using the same installation.

### REMOTE CONTROL

The remote control is chromium plated, equipped with a C. R. L. volume control, pilot light, and a key and switch combination. It is already wired to the receiver and is ready to be clamped on to the steering column. Directions for installation are furnished with the receiver.

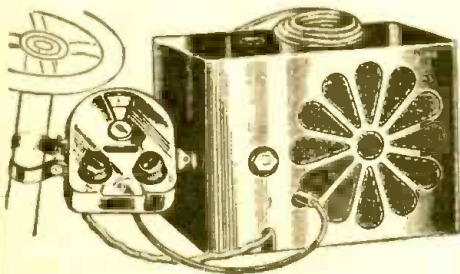

### VOLUME

The volume of the Companionette Auto Radio is equivalent to any other six or seven tube auto radio. It incorporates a tuned radio frequency circuit using two 239 tubes, one 236, and one 41 tube (new type) arranged with a semi-automatic volume control. It is also equipped with a 6 inch Dynamic Speaker from which all cables are shielded.

### RUST PROOF

The chassis is mounted into an all steel outer case—all cadmium plated and properly shielded. Will not corrode or rust. Construction is such that drain from the "A" and "B" batteries is kept down to a minimum.



### Outstanding 1933 Features!

- ★ Remote Control with no backlash.
- ★ Simple to Install (only three holes to be drilled).
- ★ Cadmium plated.
- ★ Speaker and Set Chassis in one unit.
- ★ Volume comparable to any Auto Receiver.
- ★ Selective and Sensitive.
- ★ New Type Tubes.

# \$17<sup>95</sup>

Sold for this remarkably low price, complete with tubes, individually packed, R. C. A. licensed, and with remote control.

## POWERTONE GEN-E-MOTOR AUTO "B" ELIMINATOR

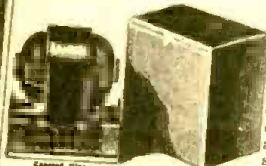

Make your auto radio reception less expensive and fully powered at all times. Here is an opportunity to do away with batteries and secure peak efficiency continuously. It is carefully constructed of segmented commutators and a built-in filter. Will deliver smooth power output for all requirements. Conservatively designed. Bearings are self lubricated, and are of ample size to minimize wear, and insure perfect alignment. Very compact, measures only 4 1/2 x 6 inches.

135 volt model with intermediate tap at 67 1/2 volts... **\$12<sup>35</sup>**  
180 volt model with intermediate tap at 90 volts.....

## ELECTRONIC AUTO "B" ELIMINATOR KIT

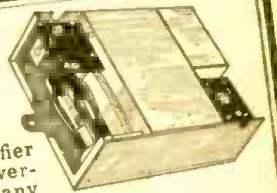

Recommended by leading engineers for auto installation. Employs the famous Electronic rectifier which will withstand tremendous overloads. Output is ample to operate any automobile radio.

- ★ Provides Constant Voltage and current at all times.
  - ★ Nothing to wear out.
  - ★ Does not set up interference.
- Supplies 180 volts at 35 M.A. or 135 volts at 46 M. A.  
Kit of parts, includes blueprints and rectifier tube, **\$8.23**  
assembled complete with tube, **\$9.98**

## Wright-De Coster Auto Speaker

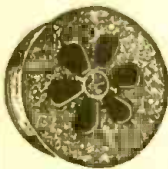

A Wright-De Coster Auto Speaker in a car will increase the performance of the receiver beyond expectations. None of the famous Wright-De Coster features are lost in the manufacture of these speakers. Every audible frequency is reproduced perfectly at any volume with brilliance and fidelity. The speaker chassis is enclosed in a metal can thus eliminating any chances of picking up ignition noises. Single stud mounting simplifies installation of speaker. For P.P. or Single 238... **\$4.45**

## Distributor Silencer



A quality suppressor. Easy to install. Merely cut the wire to the common pole of the distributor. Screw the device into each end of the wire. No tools required. A tight connection is assured by the special shank construction. A necessity for every automobile radio set. **19c**

## De Luxe Car Antenna



High efficiency and ease of installation characterize this aerial. May be readily mounted by anyone. It is placed under the running board, out of the way, and will not mar the appearance of the finest car. Placement prevents undesirable pickup from ignition system, which shields from trolley and electric cable. **\$1<sup>95</sup>**

## Spark Plug Suppressor Kit

Here is one of the most popular of suppressor kits now on the market. This kit is a necessity for all auto radio installations—entirely eliminates ignition noises. Not affected by heat or climatic conditions. Complete with distributor suppressor.

4 cylinder cars..... **\$1.35**  
6 cylinder cars..... **1.75**  
8 cylinder cars..... **2.25**



## Generator Silencer

Essential to any auto radio installation. Designed to mount on the generator frame with single wire connection. Can be connected with only a screw driver. Effectively and mechanically correct. Insures the correct degree of damping and yet does not effect car performance.



.5 mfd., **35c**  
1. mfd., **37c**

# TRY-MO RADIO CO. INC. 85 Cortlandt St. New York

178 Greenwich St., N. Y. C.  
Near Day St.

BRANCH STORES

179 Greenwich St., N. Y. C.  
Near Cortlandt St.

Note: Send Mail Orders to Dept. C6, 85 Cortlandt St., New York City.

20% deposit must accompany all C. O. D. orders.

Send for Our New Catalog



# JUNE SPECIALS!!

EVERY month we list on this page certain STAR \* items, which are NOT LISTED IN OUR CATALOG. These are all specials of which the quantities on hand are not sufficient to catalog them. Once sold out, no more can be had. First come, first served. ORDER NOW, TODAY.

STOP SHOPPING. The lowest prices are right on this page. No one undersells us. We meet any price on ANY NEW Merchandise. Order direct from this page and save money. 100% satisfaction on every transaction. Take advantage of these special offers. ORDER NOW, TODAY.

Only \$10.85

## Greatest Buy In America!

Only \$10.85

★"PEERLESS" 7-TUBE SCREEN-GRID T.R.F. RADIO RECEIVER

Complete with Full Dynamic Speaker

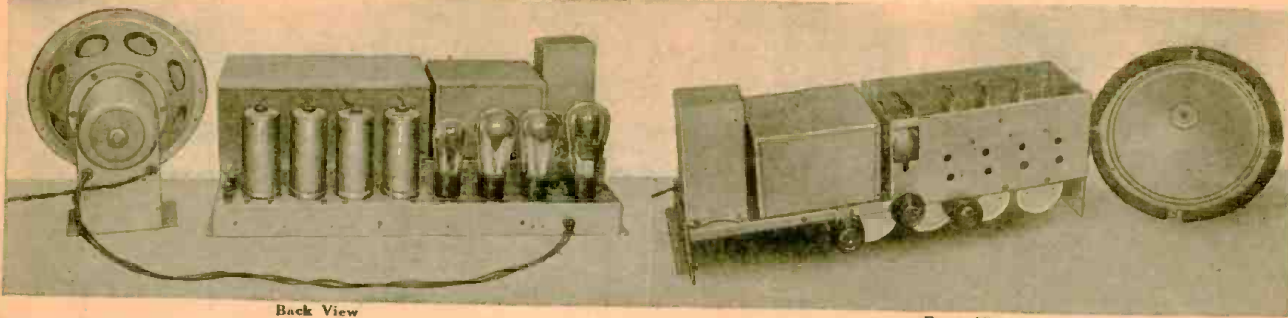

Back View

Front View

### Limited Supply—Only as Long as They Last—Order Today

IF EVER there were a greater value than this offered before, we have yet to see it. The selectivity and sensitivity of this 7-tube receiver due to its three tuned stages are just as sharp as those of an expensive 11-tube Superheterodyne receiver. The construction of this receiver is best described as "standard." Its circuit is none other than the "good old standby" TRF type which is the most reliable and the most foolproof ever designed. It incorporated two stages of tuned R.F. amplification using type "24 Screen-grid tubes; the power detector is a "24; a single stage of AF voltage amplification utilizing the type "27 tube, feeds a 247 super-power pentode, the full wave rectifier is an "80. All provisions are made for supplying field power for the 9 inch genuine Magnavox, fully shielded full dynamic speaker. Both cone and spider of this excellent reproducer are made of Buxton to improve the high note response (brilliance) without impairing the low note production.

Tuning is extremely simple, the tuned circuits being controlled by a single central knob; a vernier drum-type illuminated tuning dial is employed. The second knob controls the on-off switch and the third, the one on the right, volume control. Coils, tuning-condenser-gang, filter condenser bank, output choke and by-pass condenser bank are all individually shielded. The chassis itself is made of non-magnetic aluminum.

The use of three tuned circuits, employing screen-grid tubes and high gain R.F. transformers, together with careful wiring, and by-passing, result in high sen-

sitivity. Many of our satisfied customers inform us that a good variety of distant stations come in like locals. Tone quality, too, is extraordinarily fine. Despite the maze of new tubes recently thrown upon the market, it is generally conceded that for average home use a single 247 pentode supplies adequate power with the least distortion.

Why build a set when a complete receiver, wired and ready to use, and complete with speaker, can be bought at this phenomenally low price? Here is an excellent opportunity for wide-awake service men to "clean up." There are little more than 100 of these receivers left and at this low price, they are bound to give out in very short order. Experimenters will find in this chassis the laboratory "monitor" they have been waiting to buy "when things get cheaper." Remember that the supply is limited. Hence, "first come, first served." The moral is don't delay, order today. Overall size 21" x 8" x 8 1/2" (set only). Ship. wt. 45 lbs.

List Price \$75.00

NO. SP-2000 Peerless 7-Tube TRF Receiver

YOUR PRICE with speaker but less tubes.. \$10.85

LIMITED SUPPLY—ORDER TODAY—TOMORROW MAY BE TOO LATE

### Build Your Own "Dependable" Tube Tester!

Sold in Kit Form

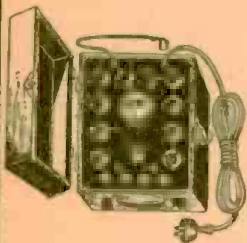

And now for the first time we present a complete kit of parts for building an advanced "DEPENDABLE" tube tester—an instrument which is MODERN in every sense of the word. Will test all the latest type tubes including those with 4, 5, 6 and 7 prongs—DIRECTLY—WITHOUT THE USE OF A SINGLE ADAPTER. Complete details for constructing this instrument were printed in the RADIO CRAFT magazine for April. (A copy of this magazine will be given FREE with each purchase.) Complete instructions are also furnished with each kit.

The "DEPENDABLE," despite its high degree of accuracy, is EXTREMELY SIMPLE TO OPERATE. Both plates of the 80—82—83 and other rectifiers are readily tested without the use of a "second plate" button. The condition of a given tube is manifested by its mutual conductance (emission) characteristic, which is clearly indicated on the meter. Employs a sensitive magnetic-vane type meter but may be had with a moving-coil type meter at an additional cost of \$4.00.

(Please specify which when ordering.) Provides for a "SHORT" test which safeguards the life of the meter. Shorted tubes are automatically indicated on a pilot light.

Operates on 105—115—125 volts A.C. with provisions for securing the proper line voltage. ONLY FIRST-CLASS PARTS ARE USED THROUGHOUT. The kit is sold complete with beautifully lithographed panel and handsome leatherette case with deluxe trimmings. Overall dimensions of completed tube checker in case 11" x 9" x 5". Ship. wt. 8 lbs.

Here is what you receive: 1—drilled and lithographed panel 10" x 9"; 1—filament transformer; 1—0-15 M.A. specially calibrated magnetic-vane meter for moving coil meter—see above; 1—7 point filament selector switch; 1—4 point line voltage selector switch; 1—6-leaf jack switch; 1—3-leaf momentary contact switch; 1—8.P.D. T. toggle switch; 1—Belden soft rubber plug and cable; 10—wafer sockets for 4-5-6 and 7 prong tubes; 1—3 watt 7,000 ohm resistor; 1—10 watt 900 ohm resistor; 2—bakelite indicator knobs; 1—18 watt pilot lamp and socket; 2—switch buttons; 1—screen-grid cap and wire; 1—leatherette case; assorted hardware, wire, etc. Ship. wt. 8 lbs.

LIST PRICE \$27.50

No. 301 Dependable Tube Tester Kit \$11.45

YOUR PRICE

No. 301A Same as above but with Moving Coil Meter. YOUR PRICE \$15.45

### Doerle 12,500 Mile Short-Wave Set

Although the Doerle is a low-priced receiver, yet it pulls in short-wave stations from all over the world. REGULARLY, in practically any location, not only in this country, but anywhere. Thousands of experimenters have built their own, and have obtained miraculous results. All the usual "bugs" have been ironed out by us in such a way that you may order every receiver with full confidence, that "it will do its stuff" anywhere. It is possible for us to sell cheaper parts for the complete receiver at a lower price. But then we could not guarantee its performance. Therefore only First Class Material is Used.

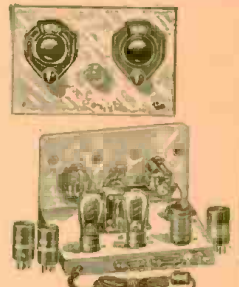

This receiver is exactly as illustrated.

Size of aluminum panel is 9 x 6 3/4 inches; base 9 x 6 3/4 inches. List of material used: 2 Hammarlund .00014 Condensers; 1 Carter 20 ohm Rheostat and Switch; 1 standard Audio Transformer; 2 Kurz-Kasch Verner Dials; 3 Bakelite Low Loss Sockets; 1 Micomoid Equalizer Antenna Condenser; 1-.0001 mica Fixed Condenser; 1-5 megohm Carborundum Grid Leak; 2 Telephone Pin Jacks; 1 Aluminum Panel; 1 Vener Baseboard; 1 Bakelite Rheostat Knob; 2 double binding posts; 1 set of 4 Low Loss Short Wave Plug-in Coils; 4-page instruction pamphlet and blue prints; 1 Set of Hardware, Wire, etc. Complete shipping weight 5 lbs.

No. 2141. TWO TUBE 12,500 MILE DOERLE SHORT-WAVE RECEIVER, completely wired and tested as per above specifications.

YOUR PRICE \$8.90

No. 2142. COMPLETE ACCESSORIES including the following: 2 six months guaranteed Neon-type No. 230 tubes; one set of No. 1678 Brandes Matched Headphones; 2 No. 6 standard dry cells; 2 standard 45-volt "B" batteries. Complete shipping weight 22 lbs.

YOUR PRICE \$7.70

YOUR PRICE \$5.40

## FREE RADIO AND SHORT WAVE TREATISE



The new Winter, 1933 edition of our Radio and Short-Wave Treatise, No. 20, has just come off the press—104 solid pages of useful information, radio items, diagrams and illustrations. Positively the greatest book in print—NOT JUST ANOTHER CATALOG. Contains a large editorial section with valuable information not found anywhere else. Special consideration has been given to the radio beginner in this issue. Among the new technical information listed are the following:

HERE IS A PARTIAL LIST OF CONTENTS

Fundamental Principles of Radio—Ohm's Law—Discussion of New Tubes—Constructing a "Triple-Twin" Amplifier—All about Superheterodynes—Eliminating Man-Made Static—Constructing a Two-Tube Short-Wave "Globe-Trotter" Receiver—\$3.00 Prize Suggestions—Radio Hints, etc., etc.

WRITE TODAY. Enclose 4 cents for postage. Treatise sent by return mail.

Over 100 New Hook-Ups, Etc. 1000 Illustrations.

WE ARE A WHOLESALE HOUSE AND CAN NOT ACCEPT ORDERS FOR LESS THAN \$3.00. If C.O.D. shipment is desired, please remit 20% remittance, which must accompany all orders. If full cash accompanies order, deduct 2% discount. Send money order—certified check—U. S. stamps.

Radio Trading Co.  
102 Park Place  
New York, N. Y.

ORDER FROM THIS PAGE. You will find special prices from time to time in this magazine. Get our big FREE catalog for the greatest Radio Bargains.

Should you wish goods shipped by parcel post, be sure to include sufficient extra remittance for same. Any excess will be refunded.



# SPECIAL Tube Offer!

We will give you this expensive Tube Tester with each order of tubes amounting to \$50 or over

**FREE**

List Price \$27.50



This modern tube tester is equipped with 4, 5, 6 and 7 probe sockets and filament control switch so that the heaters or filaments may be supplied 1.5-2.0-2.5-3-3.5-4.3 and 7.5 volts at each and every one of the ten sockets on panel.

BOTH PLATES of the 80-82-83 and other rectifiers may readily be tested. There is a "2nd Plate" button for this purpose.

GRID SHIFT test is provided for relative conductance values. Arbitrary values are clearly indicated on the meter. A simple chart is furnished so that condition of tube may be easily determined.

SHORT and gas test is also included by pressing its special button. Short will automatically be indicated on a pilot light.

OPERATED directly from AC light socket. Simple to use—complete instructions furnished. Line voltage adjustment switch insures proper reading on 105-115-125 volts at the supply lines.

PANEL is beautiful lithographed. Meter indications for all tubes are well over 1/4 of the scale, due to special design features.

HANDSOME leatherette case with handle, lock catches and "removable" hinge cover makes it convenient for portable or counter use. Indestructible type included soft rubber cord and plug. Overall dimensions approximately 11 x 9 x 5 inches.

Our sales policy is: first quality merchandise, rapid service, low price, and a square deal. All tubes are

- 1—GUARANTEED FIRST QUALITY.
- 2—R. C. A. LICENSED.
- 3—FULLY REPLACEABLE UNDER R. M. A. STANDARD POLICY.
- 4—UNIFORMLY WITHIN R. C. A. TEST LIMITS.
- 5—ATTRACTIVELY PACKED.

Manufacturer's costs determine selling prices rather than list prices—tube prices that mean more sales and greater profits. Net prices applied on all types; we list dealer's cost on all numbers.

**Complete Stock Ready for Immediate Shipment** Order from this page—Remit 20% with order, balance C. O. D. All prices are F. O. B. FACTORY, Newark. Shipments go forward express or parcel post. No order for less than \$3.00 accepted.

Type	Description	Volt- age	Your Cost	Type	Description	Volt- age	Your Cost	Type	Description	Volt- age	Your Cost	
UX-201A	Detector Amplifier	5.0	\$ .30	48	Power amplifier Tetrode D-C Heater	30.0	1.10	Switch tube, 201-A, or 112 or 171 double life	5.0	.60		
UX-226	Amplifier (A-C Filament)	1.5	.30	49	Dual Grid power amplifier	2.0	.85	Adapter tube 226, 227, 171-A to convert bat. sets to A-C, each		.60		
UY-227	Detector Amplifier (A-C Heater)	2.5	.30	55	Duplex-Diode Triode (A-C Heater)	2.5	.60	<b>RECTIFIER AND CHARGER BULBS</b>				
UX-171A	Power Amplifier 1/2 amp.	5.0	.30	56	Super-Triode amplifier (A-C Heater)	2.5	.60	UX-866	Half Wave Mercury Vapor Rectifier (heavy duty)	2.5	2.75	
UX-240	Voltage amplifier detector	5.0	.40	57	Triple grid detector Amp. (A-C Heater)	2.5	.60	IV	Half Wave Rectifier (A-C Heater)	6.3	.85	
UX-120	Power Amplifier	3.3	.40	58	Triple grid R-F amplifier (A-C Heater)	2.5	.60	UX-280M	Full Wave Mercury Vapor Rectifier	5.0	1.10	
UX-199	Detector amplifier	3.3	.40	59	Triple grid power Amp. (A-C Heater)	2.5	.60	UX-281M	Half Wave Mercury Vapor Rectifier	7.5	1.90	
UV-199	Detector amplifier short protog.	3.3	.40	75	Duplex-Diode High-Mu Triode (A-C Heater)	6.3	.85	UX-871	Half Wave Mercury Vapor Rectifier	2.5	1.10	
UX-199	With a standard 201A base	3.3	.40	77	Triple grid detector amplifier (A-C Heater)	6.3	.85	UX-280	Full Wave Rectifier	5.0	.40	
UX-112A	Amplifier detector 1/2 amp.	5.0	.40	78	Triple grid super-control R-F amp. (A-C Heater)	6.3	.85	25Z5	Rectifier-shudder (Heater)	25.0	.85	
UX-112	Amplifier detector 1/2 amp.	5.0	.40	79	Class B Twin amplifier (A-C Heater)	6.3	.85	UX-281	Half Wave Rectifier	7.5	1.10	
UX-200A	Detector	5.0	.40	85	Duplex Diode Triode (A-C Heater)	6.3	.85	UX-282	Full Wave Mercury Vapor Rectifier	2.5	.85	
UY-224	Screen grid R-F amplifier (A-C Heater)	2.5	.40	89	Triple grid power Amp. (A-C Heater)	6.3	.60	UX-283	Heavy duty full wave mercury vapor rectifier	5.0	.85	
UY-245	Power amplifier (A-C Filament)	5.0	.60	89	Triple grid power Amp. (A-C Heater)	6.3	.60	UX-216B	Half Wave Rectifier	5.0	.40	
UX-201B	Detector amplifier 1/2 amp.	5.0	.60	PZH	Power amplifier pentode (A-C Heater)	2.5	.85	UX-213	Full Wave Rectifier	5.0	.40	
UY-246	Dual Grid Power amplifier (A-C Fil.)	2.5	.60	UX-210	Power amplifier oscillator (A-C Fil.)	7.5	1.10	UY-84	Full Wave Rectifier (Heater)	6.3	.85	
UY-247	Power amplifier pentode (A-C Fil.)	2.5	.85	UX-222	Screen grid radio frequency amplifier	3.3	1.10	UX-872	7500 Volts Half Wave Mercury Vapor Rectifier		11.00	
UY-257	Power amplifier pentode (D-C Fil.)	1.1	.60	UX-250	Power amplifier (A-C Filament)	7.5	1.10	<b>PHOTO CELLS</b>				
WD-11	Detector amplifier	1.1	.60	UY-227A	Detector amplifier (quick heater) (A-C Heater)	2.5	.60	Photoelectric cell, "Potassium" Type O		2.10		
WD-12	Detector amplifier	1.1	.60	UY-224A	Screen grid R-F amplifier (quick heater) (A-C Heater)	2.5	.60	Photoelectric cell, "Caesium" Type A, 4 1/2" overall length		7.90		
UX-230	Detector amplifier	2.0	.60	UX-182	Sparton type power Amp. (A-C Fil.)	5.0	.85	Photoelectric cell, "Caesium" Type R, 3 1/2" overall length		5.90		
UX-231	Power amplifier	2.0	.60	UX-183	Sparton type power Amp. (A-C Fil.)	5.0	.85	<b>TELEVISION TUBES</b>				
UX-232	Screen grid radio frequency amplifier	2.0	.85	UY-484	Sparton type detector Amp. (A-C Heater)	3.0	.85	Telion Relectron Neon Television Tube, 1" Cathode Squares Type V		3.85		
UY-233	Power amplifier pentode	2.0	.85	UX-586	Sparton type power Amp. (A-C Fil.)	7.5	2.10	Telion Neon Television Tube, 1 1/2" Cathode Square Type W		3.85		
UX-234	Super-control R-F amplifier pentode	2.0	.85	UY-686	Sparton type amplifier	3.0	.85	Telion Neon Television Tube, 1" Cathode square Type X		2.10		
UY-235	Super-control R-F Amp. (A-C Heater)	2.5	.60	UX-401	Kellogg type triode (A-C Heater)	3.0	1.50	<b>TRANSMITTING TUBES</b>				
UY-236	Screen-Grid R-F Amp. (A-C Heater)	6.3	.85	UX-403	Kellogg type output triode (A-C Heater)	3.0	2.00	7 1/2 Watts—A-565	Screen Grid Amplifier		12.25	
UY-237	Detector amplifier (A-C Heater)	6.3	.85	Ballast tube to save tubes in set from blowing out Special super-sensitive audio freq. 201-A			5.0	.60	15 Watts—A-210-C	Oscillator and Amplifier		2.55
UY-238	R-F amplifier pentode (A-C Heater)	6.3	.85	Special super-sensitive audio freq. 201-A			5.0	.60	50 Watts—A-511	General Purpose		11.00
UY-551	Super-control R-F Amp. (A-C Heater)	2.5	.60	Special 171 A-C 1/2 amp. extra coated filament grid for electric sets			5.0	.60	50 Watts—A-514	General Purpose		11.00
2A5	Power amplifier pentode (A-C Heater)	2.5	.60	T-14 (201-A High Mu) high emission			5.0	.60	50 Watts—A-203-A	Oscillator and Amplifier		11.00
41	Power amplifier pentode (A-C Heater)	6.3	.60	The above type numbers are interchangeable with similar type numbers.					50 Watts—A-203-C	Oscillator and Amplifier		11.00
42	Power amplifier pentode (A-C Heater)	6.3	.60					50 Watts—A-845	Amplifier and Modulator		11.00	
43	Power amplifier pentode (A-C Heater)	25.0	.85					50 Watts—A-845-C	Amplifier and Modulator		11.00	
44	R-F amplifier pentode (A-C Heater)	6.3	.85					75 Watts—A-852	Oscillator and Amplifier		20.00	
								75 Watts—A-960	Screen Grid and Amplifier		15.00	
								50 Watts—A-981	Oscillator and Amplifier		15.00	

◀ This tube offer expires June 15, 1933, and by taking advantage of this SPECIAL OFFER, it will bring the cost of tubes down to the lowest price ever offered by any tube manufacturer for high quality, guaranteed radio tubes. ▶

**ARCO TUBE COMPANY, 40 PARK PLACE, NEWARK, N. J.**



Announcing  
**A NEW AUTO RADIO**  
 that will sell... *and how!*

ONLY \$ **34.95**

Complete, less antenna  
 and installation



LOOK AT THESE **10** FEATURES

- 1 Chassis, speaker and "B" eliminator all in one case. Size only 8 $\frac{3}{4}$  inches wide, 8 $\frac{3}{4}$  inches high, 7 $\frac{3}{8}$  inches deep.
- 2 Easily installed in 30 minutes—only one hole to drill.
- 3 Just two electrical connections—no soldering necessary.
- 4 Full electro dynamic speaker.
- 5 Only one in its price class with Tone Control.
- 6 New type, tubeless, double shielded vibrator "B" eliminator.
- 7 Control box fitted for variety of steering post and instrument panel mounting—no drilled holes necessary.
- 8 Efficient Automatic Volume Control.
- 9 Positive, flexible shaft from control box operates tuning without backlash; the only mechanical connection between control and receiver.
- 10 Non-glare illuminated dial, calibrated in channels.



"His Master's Voice"  
 —On the Road



Model M-34  
 —List Price  
 \$34.95



**RCA Victor Auto Radio**

RCA Victor Company, Inc., Camden, N. J.—A Radio Corporation of America Subsidiary